

Electrochemical Instrumentation

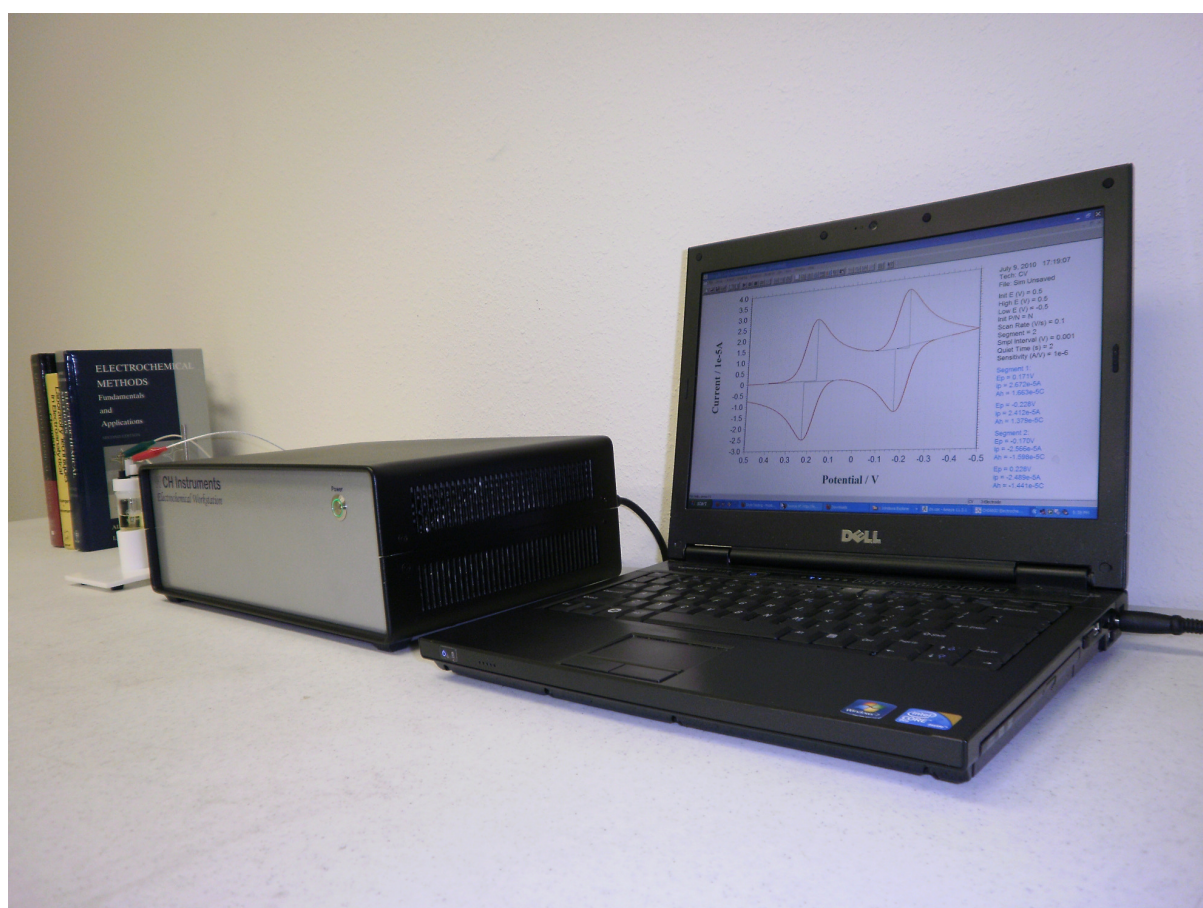

Overview

CH Instruments was established in 1994. Our first instrument series, the Model 600 series electrochemical analyzer/workstation, was introduced at the end of 1994. Since then, new products have been added to provide a full line of electrochemical instrumentation:

Model 400C Series Time-Resolved Electrochemical Quartz Crystal Microbalance (EQCM): for electrodeposition, adsorption, and chemical or biological sensor studies.

Model 600F Series Potentiostat/Galvanostat: for general purpose electrochemical measurements, such as kinetic measurements, electroanalysis, electrochemical sensor studies, fundamental research, corrosion, and battery studies.

Model 700F Series Bipotentiostat: for rotating ring-disk electrodes (RRDE) and other cases where dual channel measurements are essential.

Model 800D Series Electrochemical Detector: for either single or dual channel electrochemical detection in flow cells, capillary electrophoresis and liquid chromatography, for chemical or biological sensors, and for conventional electroanalysis.

Model 920D Scanning Electrochemical Microscope (SECM): for electrode surface, corrosion, biological samples, solid dissolution, liquid/liquid interfaces, and membrane studies.

Model 1000C Series Multi-potentiostat: 8-channel potentiostat for array electrode characterization and electrochemical sensor studies. It can be used for eight independent cells or for eight working electrodes in the same solution.

Model 1100D series Power Potentiostat/Galvanostat: for applications involving higher current and compliance voltage.

Model 1200C series Handheld Potentiostat/Bipotentiostat: for electroanalysis, electrochemical sensor studies, and field applications.

Model 1400 series 4 Channel Potentiometer / 4 Channel Potentiostats: for simultaneous measurement at a combination of sensors requiring amperometry or voltammetry and open-circuit methods, such as ion selective electrodes, can be used for multianalyte sensing, in-vitro cellular studies, in-vivo cellular studies, and generation-collection experiments.

Model 1550A Pico Liter Solution Dispenser: for making high density and high accuracy solution arrays.

All models are controlled by an external PC under the Windows 7/10 environment. The instruments are easy to install and use. No plug-in card or other hardware is required on the PC side.

These instruments provide a rich repertoire of electrochemical techniques. Most well-established electrochemical techniques can be readily employed, including potential sweep, step, pulse, alternating current, stripping, and various other techniques. For each instrument series, we provide various models to suit different needs and budgets. Our instruments offer superior performance at competitive prices, and are ideal for both research and teaching purposes.

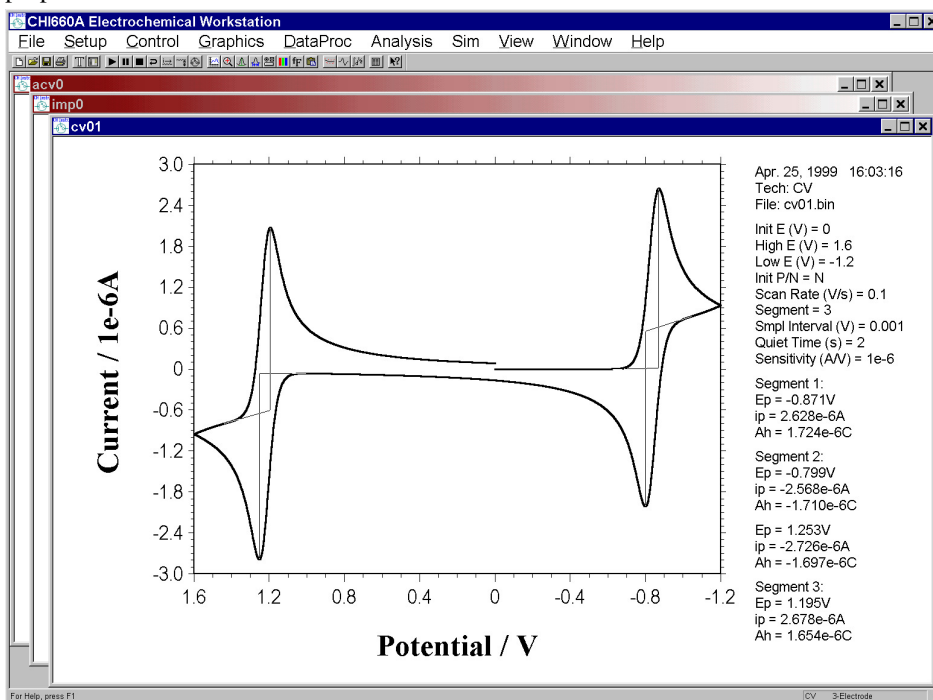

Model 400C Time-Resolved Electrochemical Quartz Crystal Microbalance

The quartz crystal microbalance (QCM) is a variant of acoustic wave microsensors that are capable of ultrasensitive mass measurements. Under favorable conditions, a typical QCM can measure a mass change of 0.1-1 ng/cm². QCM oscillates in a mechanically resonant shear mode under the influence of a high frequency AC electric field which is applied across the thickness of the crystal. Figure 1b below shows an edge view of a QCM crystal undergoing oscillatory shear distortion. The central portions of the top and bottom of the crystal are coated with a typically disk-shaped thin metal film (e.g., gold). The mass sensitivity of the QCM originates from the dependence of the oscillation frequency on the total mass of the metal-coated crystal, including any adlayers of deposited materials, as given by the Sauerbrey equation:

$$\Delta f = -2f_0^2 \Delta m / [A \sqrt{\rho\mu}]$$

where f_0 is the resonant frequency of the fundamental mode of the crystal, A is the area of the gold disk coated onto the crystal, ρ is the density of the crystal ($= 2.684 \text{ g/cm}^3$), and μ is the shear modulus of quartz ($= 2.947 \times 10^{11} \text{ g/cm} \cdot \text{s}^2$). For example, using our crystal, which has a 7.995-MHz fundamental frequency, a net change of 1 Hz corresponds to 1.34 ng of mass adsorbed or desorbed onto the crystal surface of an area of 0.196 cm².

QCM in conjunction with electrochemistry (EQCM) has been widely employed for the determination of metals deposited onto the crystal, studies of ion-transport processes in polymer films, biosensor development, and investigations of the kinetics of adsorption/desorption of adsorbate molecules. In EQCM experiments, measurements of various electrochemical parameters, such as potential, current, and charge at the working electrode, are conducted simultaneously with the acquisition of the corresponding frequency and resistance changes, using the experimental setup shown in Figure 1a. For any model in the 400C series, application of a specific potential waveform (e.g., triangular potential waveform for cyclic voltammetric experiments), current measurement, and frequency counting are carried out with a potentiostat/frequency counter, which is in turn controlled by a computer.

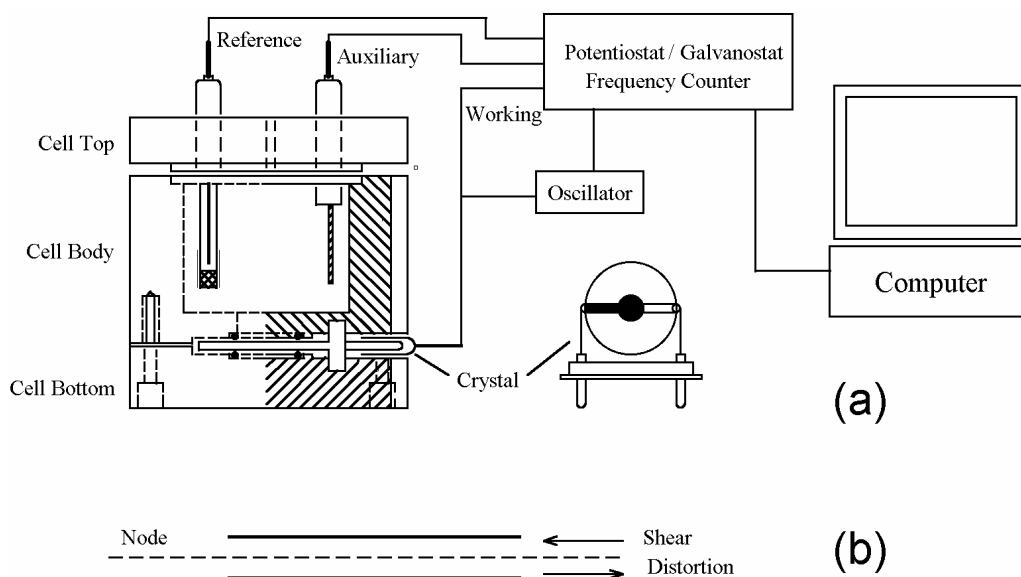

Figure 1. Schematic representation of a typical EQCM instrument. (a) The quartz crystal has a fundamental frequency of 7.995 MHz and is coated with thin gold films on both sides. The gold disk deposited on the top side of the crystal is in contact with the electrolyte solution and used as the working electrode. The top view of the gold-coated crystal is also shown. (b) Edge view of QCM crystal showing shear deformation. The disk thickness and shear deformation have been exaggerated for clarity.

The 400C series contains a quartz crystal oscillator, a frequency counter, a fast digital function generator, high-resolution and high-speed data acquisition circuitry, a potentiostat, and a galvanostat (Model 440C only). The QCM is integrated with potentiostat and galvanostat, to facilitate simple and convenient EQCM studies. Instead of measuring the frequency directly, the 400C series uses a time-resolved mode as follows. The observed frequency of the QCM is subtracted from a standard reference frequency, and the resulting difference is measured by a reciprocal

technique, greatly reducing the required sampling time and yielding much better time resolution for the QCM signal. With direct counting, a QCM resolution of 1 Hz requires 1 second of sampling time, 0.1 Hz resolution requires 10 seconds, etc. In contrast, our time-resolved mode allows the QCM signal to be measured in milliseconds with much better resolution.

The potential control range of the instrument is ± 10 V and the current range is ± 250 mA. In addition to QCM and EQCM measurements, the instrument is capable of a wide range of techniques, and is suitable for general-purpose electrochemical applications. The instrument is very sensitive and very fast, capable of measuring current down to the picoampere level. The scan rate in cyclic voltammetry can be up to 5000 V/s with a 0.1 mV potential increment or 10000 V/s with a 1 mV potential increment.

Figure 2 shows the voltammogram of underpotential and bulk depositions of Pb from a 0.1 M HClO₄ solution containing 1 mM Pb²⁺, and the corresponding frequency changes have been plotted as a function of the applied potential. In Figure 2a, the cathodic peaks at -0.28 V and at ca. -0.59 V have been assigned to the underpotential deposition of monolayer Pb and the bulk deposition of multilayers of Pb, respectively, whereas the anodic peaks at -0.41 V and at -0.28 V are attributable to the stripping of the deposited Pb. The frequency-potential diagram (Figure 2b) displays the frequency decrease due to the deposition of monolayer Pb (about 25 Hz or 33.5 ng between -0.28 V and -0.59 V) and the more drastic frequency decrease arising from bulk Pb deposition (a net change of 425 Hz or 573.8 ng at ca. -0.5 V).

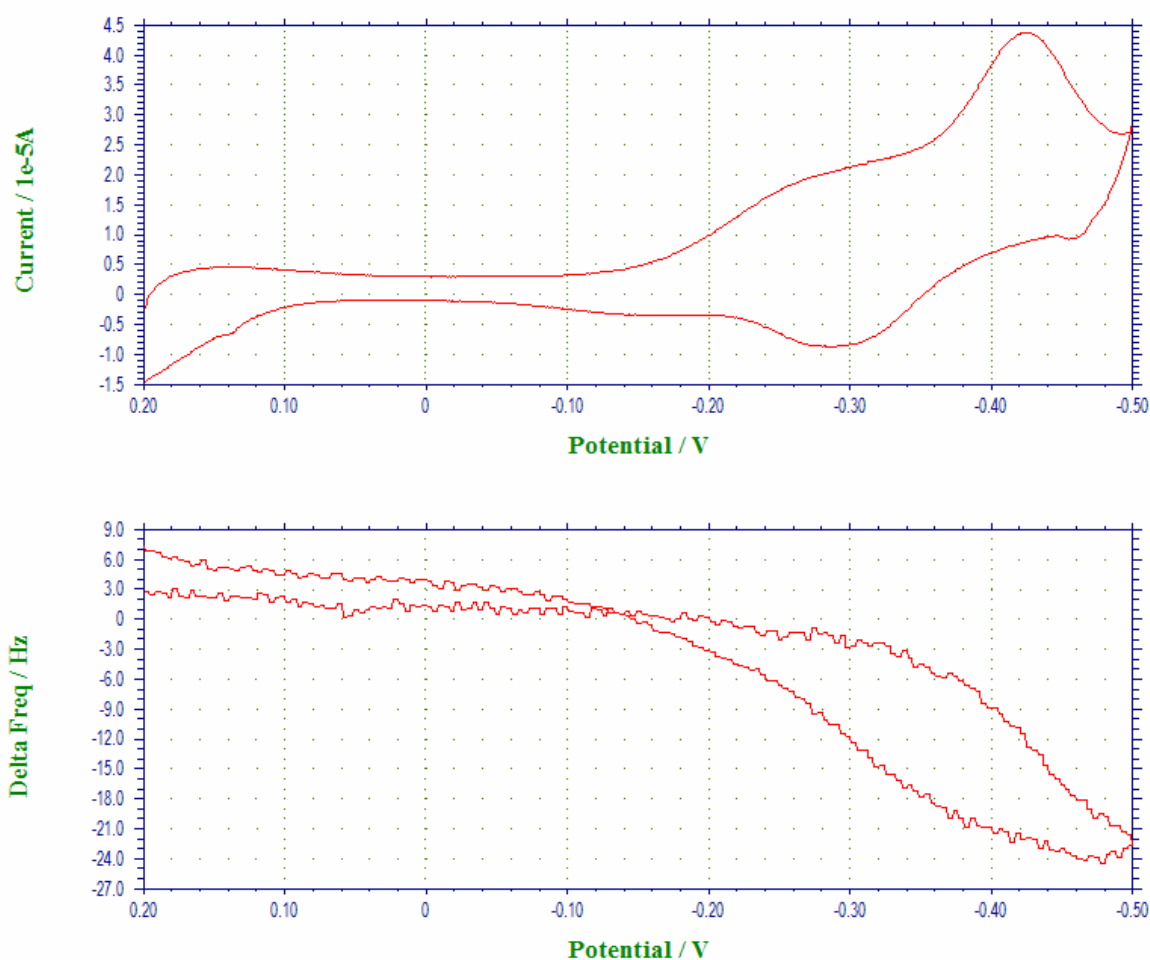

Figure 2. Voltammogram and QCM data of Pb underpotential deposition. Scan rate = 0.05 V/s.

Figure 3 depicts the voltammogram of the oxidation of pyrrole to form polypyrrole film at the gold-coated crystal and the corresponding frequency change. Five scan segments between the lower limit of -1.0 V and the upper limit of 1.0 V were conducted in this experiment. As clearly shown in Figure 3a, pyrrole monomer can be oxidized to its radical at ca. 0.65 V. When this occurred, a thin polypyrrole film was formed, resulting in a decrease of the fundamental frequency of the quartz crystal (Figure 3b). During the first potential cycle, the net frequency

change was found to be 1150 Hz. In each cycle, the oscillation frequency reached a steady value once the potential became insufficiently positive for the oxidative deposition of polypyrrole film. The subsequent potential cycles displayed in Figure 3 demonstrate the continued growth of polypyrrole film, with the deposited mass causing the crystal oscillation frequency to decrease further. A fast scan rate (0.1 V/s) was employed.

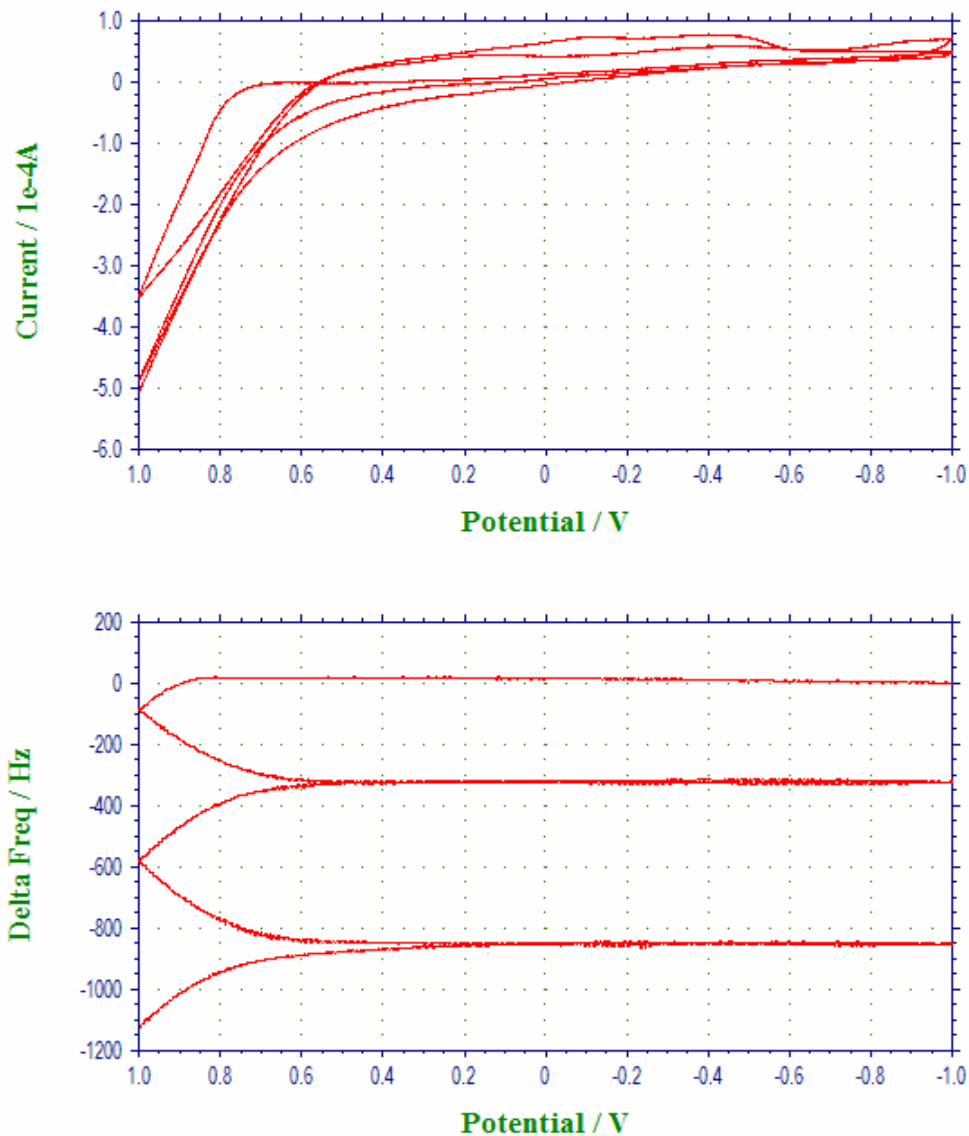

Figure 3. Voltammogram and QCM data of oxidation of pyrrole to form polypyrrole film. Scan rate 0.1 V/s.

The instrument can also be used to perform standard QCM measurements. Figure 4 shows QCM data for a flow cell detection experiment. The total frequency change observed was less than 8 Hz, with extremely low long term drift and noise levels..

The model 400C series is the upgrade to the model 400/400A/400B series. The new design provides more stable and accurate potential control (1 mV, 0.02%), and it also allows the resistance change and frequency change to be measured simultaneously.

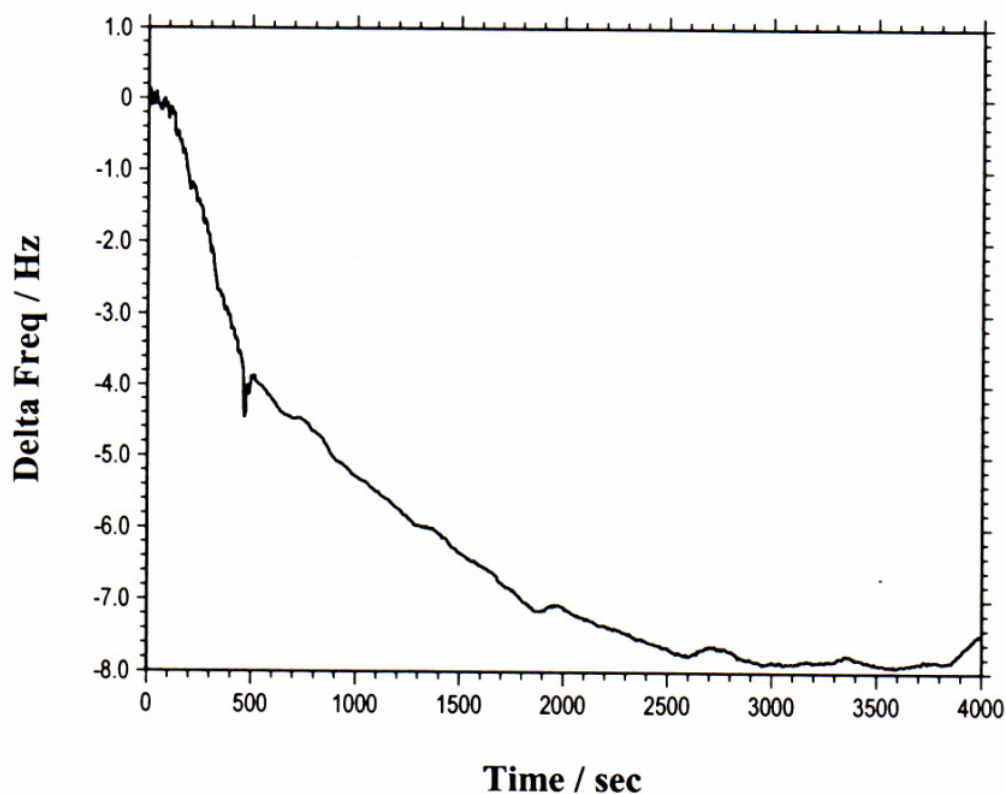

Figure 4. A typical flow injection-QCM experiment. As soon as the sample is injected, the QCM starts recording the frequency change ($t = 0$). The pump is stopped at 460 s (where a small glitch on the curve can be seen). The reaction is completed about 40 min after sample injection. The total monitoring time is over 1 hr. A net change of 8 Hz is monitored. After 40 min or so, the frequency becomes very stable again (for at least more than 20 min, the frequency drift is much less than 1 Hz).

The 400C series uses a USB port for data communication with the PC.

16-bit highly stable bias circuitry is added for current or potential bias. This allows wider dynamic range in AC measurements. It can also be used to re-zero the DC current output.

The EQCM cell consists of three round Teflon pieces (Figure 1a). The total height is 37 mm with a diameter of 35 mm. The top piece is the cell top, which holds the reference and counter electrodes. There are also two 2 mm holes for manual purging. The center piece is the solution cell, and the bottom piece is for mounting purposes. Four screws are used to tighten an O-ring seal between the bottom and center pieces, with the quartz crystal sandwiched between them. The diameter of the quartz crystal is 13.7 mm. The gold electrode diameter is 5.1 mm.

Specifications

Potentiostat
 Galvanostat (Model 440C)
 2, 3, or 4-electrode configuration
 Potential range: -10 to 10V
 Applied potential accuracy: ± 1 mV, $\pm 0.02\%$ of scale
 Potentiostat rise time: < 2 μ s
 Compliance voltage: ± 12 V
 Maximum current: ± 250 mA continuous, ± 350 mA peak
 Reference electrode input impedance: 1×10^{12} ohm
 Sensitivity scale: 1×10^{-12} - 0.1 A/V in 12 ranges
 Input bias current: < 50 pA
 Current resolution: 0.0015% of current range, minimum 0.3 fA
 Minimum potential increment in CV: 100 μ V
 Fast waveform update: 10 MHz @ 16-bit
 Data acquisition: 16 bit @ 1 MHz
 External signal recording channel
 QCM Frequency resolution: < 0.1 Hz
 QCM maximum sampling rate: 1 kHz
 Automatic and manual iR compensation

CV and LSV scan rate: 0.000001 to 5000 V/s
 Potential increment during scan: 0.1 mV @ 1000 V/s
 CA and CC pulse width: 0.0001 to 1000 sec
 CA and CC minimum sample interval: 1 μ s
 CA and CC Steps: 320
 DPV and NPV pulse width: 0.001 to 10 sec
 SWV frequency: 1 to 100 kHz
 i-t sample interval: minimum 1 μ s
 ACV frequency: 0.1 to 10 kHz
 SHACV frequency: 0.1 to 5 kHz
 Low-pass signal filters, automatic and manual setting
 Potential and current analog output
 RDE rotation control output: 0 - 10 V (430C and up)
 CV simulation and fitting program
 Cell control: purge, stir, knock
 Data length: 128K – 16384K selectable
 Dimension: 14.25"(W) \times 9.25"(D) \times 4.75"(H)
 Oscillator Box (external): 4.75"(L) \times 2.6" (W) \times 1.55" (H)
 Weight: 12 Lb.

Differences of 400C Series Models

<i>Functions</i>	<i>400C</i>	<i>410C</i>	<i>420C</i>	<i>430C</i>	<i>440C</i>
Cyclic Voltammetry (CV)	●	●	●	●	●
Linear Sweep Voltammetry (LSV) ^{&}	●	●	●	●	●
Staircase Voltammetry (SCV) ^{#, &}				●	●
Tafel Plot (TAFEL)				●	●
Chronoamperometry (CA)	●		●	●	●
Chronocoulometry (CC)	●		●	●	●
Differential Pulse Voltammetry (DPV) ^{#, &}		●	●	●	●
Normal Pulse Voltammetry (NPV) ^{#, &}		●	●	●	●
Differential Normal Pulse Voltammetry (DNPV) ^{#, &}					●
Square Wave Voltammetry (SWV) ^{&}			●	●	●
AC Voltammetry (ACV) ^{#, &, \$}				●	●
2nd Harmonic AC Voltammetry (SHACV) ^{#, &, \$}				●	●
Amperometric I-t Curve (I-t)				●	●
Differential Pulse Amperometry (DPA)					●
Double Differential Pulse Amperometry (DDPA)					●
Triple Pulse Amperometry (TPA)					●
Bulk Electrolysis with Coulometry (BE)	●		●	●	●
Hydrodynamic Modulation Voltammetry (HMV)					●
Sweep-Step Functions (SSF)					●
Multi-Potential Steps (STEP)					●
Chronopotentiometry (CP)					●
Chronopotentiometry with Current Ramp (CPCR)					●
Potentiometric Stripping Analysis (PSA)					●
Open Circuit Potential - Time (OCPT)	●	●	●	●	●
Quartz Crystal Microbalance (QCM)	●	●	●	●	●
Galvanostat					●
RDE control (0-10V output)				●	●
Full version of CV simulator				●	●
Limited version of CV simulator	●	●	●		
iR Compensation	●	●	●	●	●

#: Corresponding polarographic mode can be performed.
 &: Corresponding stripping mode can be performed.
 \$: Phase selective data are available.

Model 600F Series Electrochemical Analyzer / Workstation

The Model 600F series is designed for general purpose electrochemical measurements. The figure below shows the block diagram of the instrument. The system contains a fast digital function generator, a direct digital synthesizer for high frequency AC waveforms, high speed dual-channel data acquisition circuitry, a potentiostat, and a galvanostat (available only in select models). The potential control range is ± 10 V and the current range is ± 250 mA. The instrument is capable of measuring current down to picoamperes. With the CHI200B Picoamp Booster and Faraday Cage (fully automatic and compatible with the CHI600F series), currents at sub-picoamperes can be measured. The instrument is very fast. The function generator can update at a 10 MHz rate. Two high speed and high resolution data acquisition channels allow both current and potential (or an external voltage signal) to be sampled simultaneously at a rate of 2.5 MHz, with 16-bit resolution. The instrument provides a very wide dynamic range of experimental time scales. For instance, the scan rate in cyclic voltammetry can be up to 1000 V/s with a 0.1 mV potential increment or 5000 V/s with a 1 mV potential increment. The potentiostat / galvanostat uses a 4-electrode configuration, allowing it to be used for liquid/liquid interface measurements, and eliminating the effect of the contact resistance of connectors and relays for high current measurements. The data acquisition systems also allow an external input signal (such as spectroscopic) to be recorded simultaneously during an electrochemical measurement.

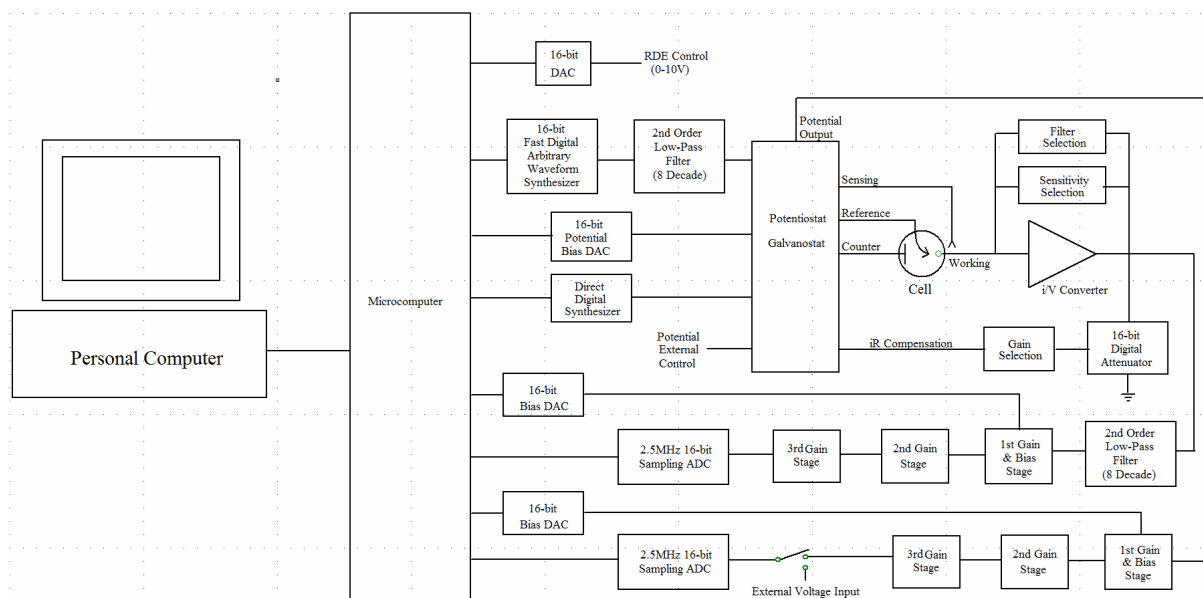

The 600F series is the latest upgrade to our very popular 600/A/B/C/D/E series.

The changes will be faster data acquisition, 16-bit resolution, two channel simultaneously AD conversion will be 2.5M Hz. It was 1M Hz two channel simultaneous ADC.

It allows CV at 2500V/s scan rate with 1 mV sample interval. It was at 1000V/s scan rate for 1mV sample interval.

CA sample interval is changed from 1 usec to 0.4 usec, two channel simultaneously.

The new model has faster data transfer with USB 3 port. The real time data transfer for CV is changed from 3V/s to 12V/s. For time based techniques (such as CA and i-t), the sample interval for real time data transfer is changed from 0.0003333 sec to 0.0001 sec.

AC impedance has a frequency up to 3M Hz.

We added current interrupt iR compensation.

We added galvanostatic intermittent titration technique (GITT) and potentiostatic intermittent titration technique (PITT).

The 600F series also includes a true integrator for chronocoulometry.

Two 16-bit highly stable bias circuits are used for current and potential bias, allowing a wider dynamic range in AC measurements. These can also be used to re-zero the DC current output.

The model 600F series can be upgraded to the corresponding model 700F series bipotentiostat with an add-on board that includes circuitry for the second channel's potential control, current measurement (including

sensitivity switching), two low-pass filters, three gain stages, and channel selection. It is therefore identical to the 600F series when used for single channel measurements. When it is used as a bipotentiostat, the second channel can be controlled at an independent constant potential, to scan or step at the same potential as the first channel, or to scan with a constant potential difference with the first channel. The second channel is available for many voltammetric and amperometric techniques.

The instrument is capable of a wide variety of electrochemical techniques, and is available with integrated simulation and fitting software functions for both impedance and cyclic voltammetry. These features provide powerful tools for both electrochemical mechanistic studies and trace analysis, as well as electrochemical sensor studies.

We provide several different models in the 600F series. The following table compares the different models. Other than what is listed, the specifications and features of these models are identical.

Specifications

Potentiostat:

- Zero resistance ammeter
- 2- or 3- or 4-electrode configuration
- Floating (isolated from earth) or earth ground
- Maximum potential: ± 10 V
- Maximum current: ± 250 mA continuous, ± 300 mA peak
- Compliance Voltage: ± 13 V
- Potentiostat rise time: < 1 μ s, 0.8 μ s typical
- Potentiostat bandwidth (-3 dB): 1 MHz
- Applied potential ranges: ± 10 mV, ± 50 mV, ± 100 mV, ± 650 mV, ± 3.276 V, ± 6.553 V, ± 10 V
- Applied potential resolution: 0.0015% of potential range
- Applied potential accuracy: ± 1 mV, $\pm 0.01\%$ of scale
- Applied potential noise: < 10 μ V rms
- Measured current range: ± 10 pA to ± 0.25 A in 12 ranges
- Measured current resolution: 0.0015% of current range, minimum 0.3 fA
- Current measurement accuracy: 0.2% if current range $\geq 1e-6$ A/V, 1% otherwise
- Input bias current: < 10 pA

Galvanostat:

- Galvanostat applied current range: 3 nA – 250 mA
- Applied current accuracy: 20 pA $\pm 0.2\%$ if $> 3e-7$ A, $\pm 1\%$ otherwise
- Applied current resolution: 0.03% of applied current range
- Measured potential range: ± 0.025 V, ± 0.1 V, ± 0.25 V, ± 1 V, ± 2.5 V, ± 10 V
- Measured potential resolution: 0.0015% of measured range

Electrometer:

- Reference electrode input impedance: $1e12$ ohm
- Reference electrode input bandwidth: 10 MHz
- Reference electrode input bias current: ≤ 10 pA @ 25° C

Waveform Generation and Data Acquisition:

- Fast waveform update: 10 MHz @ 16-bit
- Fast data acquisition: dual channel 16-bit ADC, $2,500,000$ samples/sec simultaneously
- External signal recording channel at maximum 2.5 MHz sampling rate

Experimental Parameters:

- CV and LSV scan rate: 0.000001 to $10,000$ V/s
- Potential increment during scan: 0.1 mV @ $1,000$ V/s
- CA and CC pulse width: 0.0001 to 1000 sec
- CA minimum sample interval: 0.4 μ s
- True integrator for CC
- DPV and NPV pulse width: 0.001 to 10 sec
- SWV frequency: 1 to 100 kHz
- i-t sample interval: minimum 0.4 μ s
- ACV frequency: 0.1 to 10 kHz
- SHACV frequency: 0.1 to 5 kHz
- FTACV frequency: 0.1 to 50 Hz, simultaneously acquire 1st, 2nd, 3rd, 4th, 5th, and 6th harmonics ACV data
- IMP frequency: 0.00001 to 3 MHz
- IMP amplitude: 0.00001 V to 0.7 V rms

Other Features:

- Automatic and manual positive feedback iR compensation
- Current interrupt iR compensation
- Current measurement bias: full range with 16-bit resolution
- Potential measurement bias: ± 10 V with 16-bit resolution
- External potential input
- Potential and current analog output
- Programmable potential filter cutoff: 1.5 MHz, 150 KHz, 15 KHz, 1.5 KHz, 150 Hz, 15 Hz, 1.5 Hz, 0.15 Hz
- Programmable signal filter cutoff: 1.5 MHz, 150 KHz, 15 KHz, 1.5 KHz, 150 Hz, 15 Hz, 1.5 Hz, 0.15 Hz
- RDE control output (Model 630E and up): $0-10$ V (corresponding to $0-10000$ rpm), 16-bit, 0.003% accuracy
- Digital input/output lines programmable through macro command
- Flash memory for quick software update
- USB port for data communication
- Cell control: purge, stir, knock
- CV simulation and fitting program, user-defined mechanisms
- Impedance simulation and fitting program
- Maximum data length: 256 K- 16384 K selectable
- Dimensions: $14.25''$ (W) \times $9.25''$ (D) \times $4.75''$ (H)
- Weight: 12 lb.

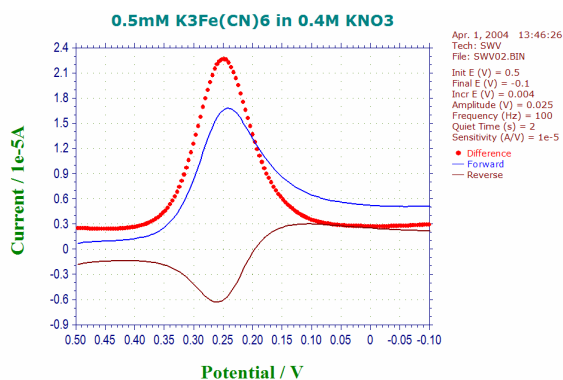

Square wave voltammogram.

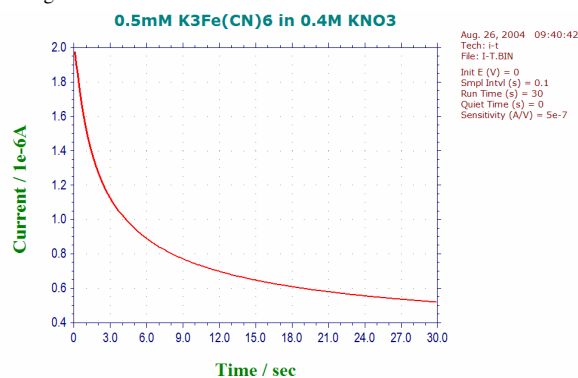

Amperometric i-t Curve.

Differences of 600F Series Models

Functions	600F	602F	604F	610F	620F	630F	650F	660F
Cyclic Voltammetry (CV)	●	●	●	●	●	●	●	●
Linear Sweep Voltammetry (LSV) &	●	●	●	●	●	●	●	●
Staircase Voltammetry (SCV) #,&						●	●	●
Tafel Plot (TAFEL)		●	●			●	●	●
Chronoamperometry (CA)	●	●	●		●	●	●	●
Chronocoulometry (CC)	●	●	●		●	●	●	●
Differential Pulse Voltammetry (DPV) #,&				●	●	●	●	●
Normal Pulse Voltammetry (NPV) #,&				●	●	●	●	●
Differential Normal Pulse Voltammetry (DNPV) #,&								●
Square Wave Voltammetry (SWV) &					●	●	●	●
AC Voltammetry (ACV) #,&,\$						●	●	●
2 nd Harmonic AC Voltammetry (SHACV) #,&,\$						●	●	●
Fourier Transform AC Voltammetry (FTACV)								●
Amperometric i-t Curve (i-t)						●	●	●
Differential Pulse Amperometry (DPA)								●
Double Differential Pulse Amperometry (DDPA)								●
Triple Pulse Amperometry (TPA)								●
Integrated Pulse Amperometric Detection (IPAD)								●
Bulk Electrolysis with Coulometry (BE)	●	●	●		●	●	●	●
Hydrodynamic Modulation Voltammetry (HMV)							●	●
Sweep-Step Functions (SSF)							●	●
Multi-Potential Steps (STEP)							●	●
Potentiostatic Intermittent Titration Tech (PITT)								●
AC Impedance (IMP)			●				●	●
Impedance - Time (IMPT)			●				●	●
Impedance - Potential (IMPE)			●				●	●
Chronopotentiometry (CP)								●
Chronopotentiometry with Current Ramp (CPCR)								●
Multi-Current Steps (ISTEP)								●
Galvanostatic Intermittent Titration Tech (GITT)								●
Potentiometric Stripping Analysis (PSA)								●
Electrochemical Noise Measurement (ECN)								●
Open Circuit Potential - Time (OCPT)	●	●	●	●	●	●	●	●
Galvanostat								●
RDE control (0-10V output)						●	●	●
Full version of CV simulation and fitting program						●	●	●
Limited version of CV simulation and fitting program	●	●	●	●	●			
Impedance simulation and fitting program			●				●	●
iR Compensation	●	●	●	●	●	●	●	●
External Potential Input	●	●	●	●	●	●	●	●
Auxiliary Signal Measurement Channel	●	●	●	●	●	●	●	●

#: Corresponding polarographic mode can be performed.

&: Corresponding stripping mode can be performed.

\$: Phase selective data are available.

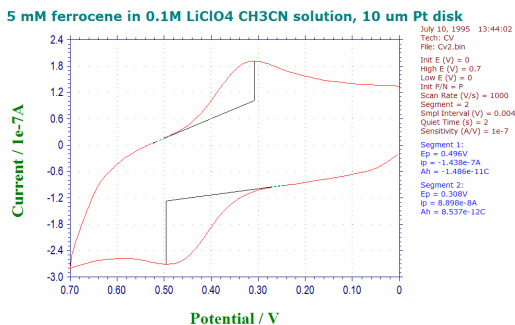

Cyclic voltammogram at 1000V/s.

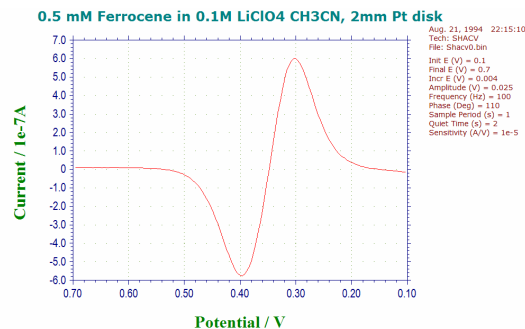

Phase selective second harmonic AC voltammogram.

Model 700F Series Bipotentiostat

The Model 700F series are computerized general purpose potentiostat / bipotentiostat / galvanostat instruments. A typical application involves a rotating ring-disk electrode (RRDE), but these systems can also be used for other applications where dual channel measurements are essential, such as dual channel electrochemical detection. The system contains a fast digital function generator, a direct digital synthesizer for high frequency AC waveforms, high speed dual-channel data acquisition circuitry, (bi)potentiostat, and a galvanostat (only available in select models). The potential control range is ± 10 V and the current range is ± 250 mA. The instrument is capable of measuring current down to tens of picoamperes. The steady state current of a 10 μ m disk electrode can be readily measured without external adapters. With the CHI200B Picoamp Booster and Faraday Cage (fully automatic and compatible with the 700E series), currents down to 1 pA can be measured (primary current channel only). These instruments are very fast. The function generator can update at a 10 MHz rate. Two high speed and high resolution data acquisition channels allow both current channels or current and potential (or an external voltage signal) to be sampled simultaneously at 2.5 MHz rate with 16-bit resolution. The instrument provides a very wide dynamic range of experimental time scales. For instance, the scan rate in cyclic voltammetry can be up to 1000 V/s with a 0.1 mV potential increment or 5000 V/s with a 1 mV potential increment. The potentiostat / galvanostat uses a 4-electrode configuration, allowing it to be used for liquid/liquid interface measurements and eliminating the effect of the contact resistance of connectors and relays for high current measurements. The data acquisition systems allow an external input signal (such as spectroscopic) to be recorded simultaneously during an electrochemical measurement. The instrument will also automatically re-zero both potential and current, so that periodic re-calibration of the instrument can be avoided.

The 700F series shares many common features with the 600F series. When used as a single channel potentiostat, the instrument is identical to the model 600F series. The bipotentiostat is realized with an add-on board that includes circuitry for the second channel's potential control, current measurement, two filter stages, three extra gain stages, and channel selection circuitry. When it is used as a bipotentiostat, the second channel can be controlled at an independent constant potential, to scan or step at the same potential as the first channel. In case of CV, it can also scan with a constant potential difference with the first channel. Techniques available for the second channel include CV, LSV, SCV, CA, DPV, NPV, SWV, and i-t.

The 700F series is the latest upgrade to our very popular 700/A/B/C/D/E series.

The changes will be faster data acquisition, 16-bit resolution, two channel simultaneously AD conversion will be 2.5M Hz. It was 1M Hz two channel simultaneous ADC.

It allows CV at 2500V/s scan rate with 1 mV sample interval. It was at 1000V/s scan rate for 1mV sample interval.

CA sample interval is changed from 1 usec to 0.4 usec, two channel simultaneously.

The new model has faster data transfer with USB 3 port. The real time data transfer for CV is changed from 3V/s to 12V/s. For time based techniques (such as CA and i-t), the sample interval for real time data transfer is changed from 0.0003333 sec to 0.0001 sec.

AC impedance has a frequency up to 3M Hz.

We added current interrupt iR compensation.

We added galvanostatic intermittent titration technique (GITT) and potentiostatic intermittent titration technique (PITT).

Two 16-bit highly stable bias circuits are used for current and potential bias, allowing wider dynamic range in AC measurements. These can also be used to re-zero the DC current output.

The instrument is capable of a wide variety of electrochemical techniques, and is available with integrated simulation and fitting software functions for both impedance and cyclic voltammetry. These features provide powerful tools for both electrochemical mechanistic studies and trace analysis, as well as electrochemical sensor studies.

We provide several different models in the 700F series. The following table compares the different models. Other than what is listed, the specifications and features of these models are identical.

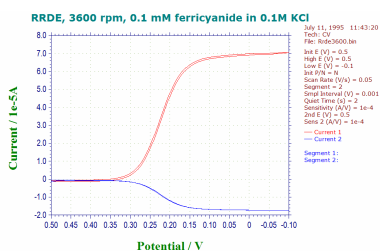

Voltammogram at rotating ring-disk electrode.

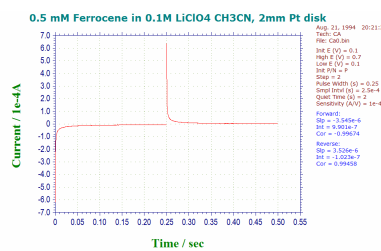

Chronoamperometric data.

Specifications

Potentiostat / Bipotentiostat:

- Zero resistance ammeter
- 2- or 3- or 4-electrode configuration
- Floating (isolated from earth) or earth ground
- Maximum potential: ± 10 V for both channels
- Maximum current: ± 250 mA continuous (sum of two current channels), ± 300 mA peak
- Compliance Voltage: ± 13 V
- Potentiostat rise time: < 1 μ s, 0.8 μ s typical
- Potentiostat bandwidth (-3 dB): 1 MHz
- Applied potential ranges: ± 10 mV, ± 50 mV, ± 100 mV, ± 650 mV, ± 3.276 V, ± 6.553 V, ± 10 V
- Applied potential resolution: 0.0015% of potential range
- Applied potential accuracy: ± 1 mV, $\pm 0.01\%$ of scale
- Applied potential noise: < 10 μ V rms
- Measured current range: ± 10 pA to ± 0.25 A in 12 ranges
- Measured current resolution: 0.0015% of current range, minimum 0.3 fA
- Current measurement accuracy: 0.2% if current range $\geq 1e-6$ A/V, 1% otherwise
- Input bias current: < 20 pA

Galvanostat:

- Galvanostat applied current range: 3nA – 250mA
- Applied current accuracy: 20 pA $\pm 0.2\%$ if $> 3e-7$ A, $\pm 1\%$ otherwise
- Applied current resolution: 0.03% of applied current range
- Measured potential range: ± 0.025 V, ± 0.1 V, ± 0.25 V, ± 1 V, ± 2.5 V, ± 10 V
- Measured potential resolution: 0.0015% of measured range

Electrometer:

- Reference electrode input impedance: $1e12$ ohm
- Reference electrode input bandwidth: 10 MHz
- Reference electrode input bias current: ≤ 10 pA @ 25°C

Waveform Generation and Data Acquisition:

- Fast waveform update: 10 MHz @ 16-bit
- Fast data acquisition: dual channel 16-bit ADC, 1,000,000 samples/sec simultaneously
- External signal recording channel at maximum 2.5 MHz sampling rate

Experimental Parameters:

- CV and LSV scan rate: 0.000001 to 10,000 V/s, two channels simultaneously
- Potential increment during scan: 0.1 mV @ 1,000 V/s
- CA and CC pulse width: 0.0001 to 1000 sec
- CA minimum sample interval: 0.4 μ s, both channels
- CC minimum sample interval: 1 μ s
- True integrator for CC
- DPV and NPV pulse width: 0.001 to 10 sec
- SWV frequency: 1 to 100 kHz
- i-t sample interval: minimum 1 μ s, both channels
- ACV frequency: 0.1 to 10 kHz
- SHACV frequency: 0.1 to 5 kHz
- FTACV frequency: 0.1 to 50 Hz, simultaneously acquire 1st, 2nd, 3rd, 4th, 5th, and 6th harmonics ACV data
- IMP frequency: 0.00001 to 3 MHz
- IMP amplitude: 0.00001 V to 0.7 V rms

Other Features:

- Automatic and manual positive feedback iR compensation
- Current interrupt iR compensation
- Current measurement bias: full range with 16-bit resolution
- Potential measurement bias: ± 10 V with 16-bit resolution
- External potential input
- Potential and current analog output
- Programmable potential filter cutoff: 1.5 MHz, 150 KHz, 15 KHz, 1.5 KHz, 150 Hz, 15 Hz, 1.5 Hz, 0.15 Hz
- Programmable signal filter cutoff: 1.5 MHz, 150 KHz, 15 KHz, 1.5 KHz, 150 Hz, 15 Hz, 1.5 Hz, 0.15 Hz
- RDE control output (Model 730F and up): 0-10V (corresponding to 0-10000 rpm), 16-bit, 0.003% accuracy
- Digital input/output lines programmable through macro command
- Flash memory for quick software update
- USB port for data communication
- Cell control: purge, stir, knock
- Maximum data length: 256K-16384K selectable
- CV simulation and fitting program, user defined mechanisms
- Impedance simulation and fitting program
- Dimension: 14.25"(W) \times 9.25"(D) \times 4.75"(H)
- Weight: 12 lb.



Differences of 700F Series Models

Functions	700F	710F	720F	730F	750F	760F
Cyclic Voltammetry (CV)*	●	●	●	●	●	●
Linear Sweep Voltammetry (LSV) &.*	●	●	●	●	●	●
Staircase Voltammetry (SCV) #,&.*				●	●	●
Tafel Plot (TAFEL)				●	●	●
Chronoamperometry (CA)*	●		●	●	●	●
Chronocoulometry (CC)	●		●	●	●	●
Differential Pulse Voltammetry (DPV) #,&.*		●	●	●	●	●
Normal Pulse Voltammetry (NPV) #,&.*		●	●	●	●	●
Differential Normal Pulse Voltammetry (DNPV) #,&						●
Square Wave Voltammetry (SWV) &.*			●	●	●	●
AC Voltammetry (ACV) #,&.\$				●	●	●
2nd Harmonic AC Voltammetry (SHACV) #,&.\$				●	●	●
Fourier Transform AC Voltammetry (FTACV)						●
Amperometric i-t Curve (i-t)*				●	●	●
Differential Pulse Amperometry (DPA)					●	●
Double Differential Pulse Amperometry (DDPA)					●	●
Triple Pulse Amperometry (TPA)					●	●
Integrated Pulse Amperometric Detection (IPAD)						●
Bulk Electrolysis with Coulometry (BE)	●		●	●	●	●
Hydrodynamic Modulation Voltammetry (HMV)					●	●
Sweep-Step Functions (SSF)					●	●
Multi-Potential Steps (STEP)					●	●
Potentiostatic Intermittent Titration Tech (PITT)						●
AC Impedance (IMP)					●	●
Impedance - Time (IMPT)					●	●
Impedance - Potential (IMPE)					●	●
Chronopotentiometry (CP)						●
Chronopotentiometry with Current Ramp (CPCR)						●
Multi-Current Steps (ISTEP)						●
Galvanostatic Intermittent Titration Tech (GITT)						●
Potentiometric Stripping Analysis (PSA)					●	●
Electrochemical Noise Measurement (ECN)						●
Open Circuit Potential - Time (OCPT)	●	●	●	●	●	●
Galvanostat						●
RDE control (0-10V output)				●	●	●
Full version of CV simulation and fitting program				●	●	●
Limited version of CV simulation and fitting program	●	●	●			
Impedance simulation and fitting program					●	●
iR Compensation	●	●	●	●	●	●
External Potential Input	●	●	●	●	●	●
Auxiliary Signal Measurement Channel	●	●	●	●	●	●

#: Corresponding polarographic mode can be performed.

&: Corresponding stripping mode can be performed.

\$. Phase selective data are available.

*: Second channel (bipotentiostat mode) can be performed.

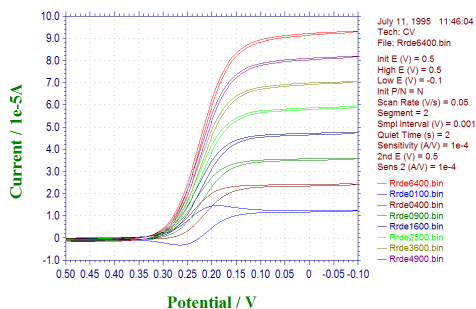

RDE Voltammograms at different rotation rates

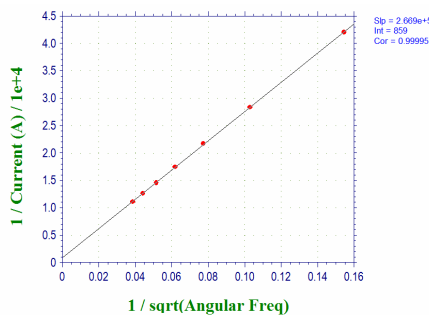

Koutecky-Levich plot

Model 800D Series Electrochemical Detector

The Model 800D series is designed for electrochemical detection; it can be used for monitoring the current passing through a flow cell in liquid chromatography/electrochemistry or in-flow injection analysis, as well as other electroanalytical applications. The system contains a digital function generator, a data acquisition system, and a potentiostat / bipotentiostat / galvanostat. The potential control range is ± 10 V, the current range is ± 10 mA, and the maximum sampling rate is 1 MHz at 16-bit resolution. The instrument is capable of measuring current down to picoamperes. This series is designed for analytical use that requires high sensitivity and low noise levels, and its circuitry has very low electrical noise. The instrument allows an external input signal (such as spectroscopic) to be recorded simultaneously with electrochemical measurements. When used for amperometric detection, three decades of current scales are plotted during the experiment to display signals of various magnitudes clearly. Compared with analog instruments, this instrument is much easier to use and also includes standard digital data storage and analysis capabilities, without the need for recorder or baseline adjustments. It also provides a much larger current dynamic range, so that separate runs for large and weak signals can be avoided.

The Model 8x0D performs single channel measurements, while the Model 8x2D contains a bipotentiostat for dual-channel measurements, such as rotating ring-disk electrode applications. Dual channel measurements are available for CV, LSV, CA, DPV, NPV, SWV, and amperometric i-t techniques. The 2nd channel can be controlled at an independent constant potential, to scan or step at the same potential as the first channel, or to CV scan at a constant potential difference with the first channel.

The model 800D series is an upgrade to our model 800/800A/800B/800C series. The instrument utilizes flash memory, allowing instrument firmware updates to be done by electronic file transfer.

The 800D series uses a USB port for data communication with the PC.

The 800D series also has a true integrator for chronocoulometry.

Several different models are available in the 800D series. The following table compares the different models. Other than what is listed, the specifications and features of these models are identical. Models 800D/802D and 810D/812D are mainly for flow cell detection. Models 820D/822D are intended for voltammetry applications and cannot be used for flow cell detection. Models 830D/832D are comprehensive electrochemical analyzers that can be used for electrochemical detection, electrochemical sensor studies, voltammetry, and other applications. Models 840D/842D and 850D/852D are more advanced models with a galvanostat. Models 850D/852D also include AC voltammetry capabilities.

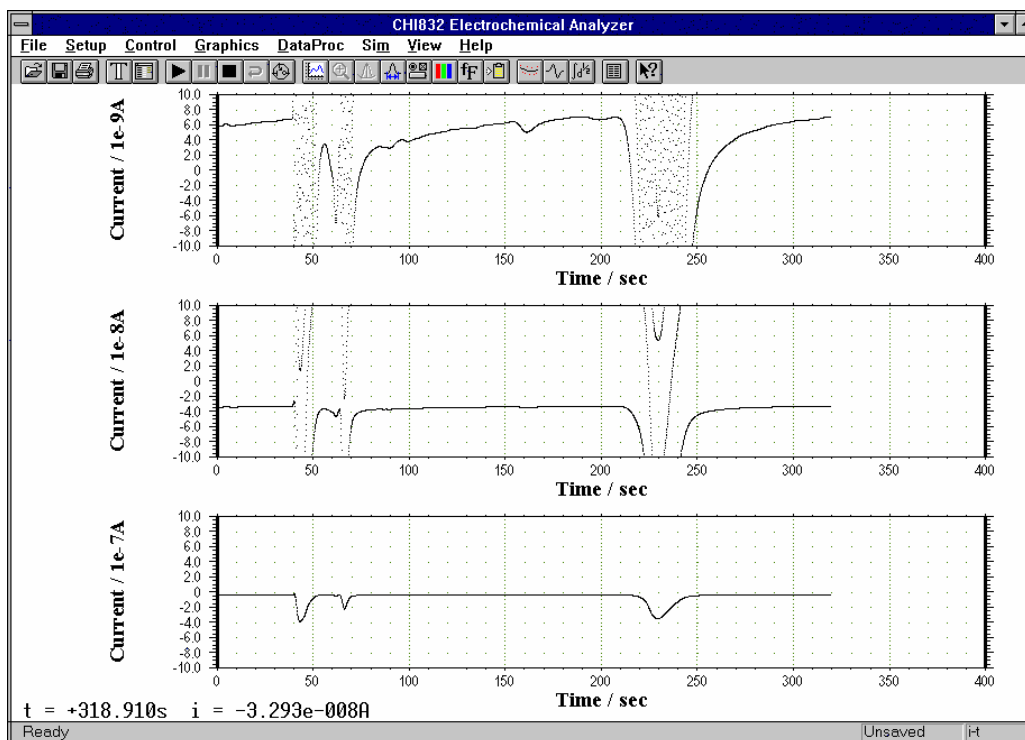

Real time data display for flow cell detection.

Specifications

Potentiostat / Bipotentiostat:

- Zero resistance ammeter
- 2, 3, or 4-electrode configuration
- Floating (isolated from earth) or earth ground
- Maximum potential: ± 10 V for both channels
- Maximum current: ± 10 mA
- Compliance Voltage: ± 13 V
- Potentiostat rise time: < 2 μ s
- Applied potential ranges: ± 3.276 V, ± 6.553 V, ± 10 V
- Applied potential resolution: 0.0015% of potential range
- Applied potential accuracy: ± 1 mV, $\pm 0.01\%$ of scale
- Applied potential noise: < 10 μ V rms
- Measured current range: ± 10 pA to ± 0.001 A in 10 ranges
- Current resolution: 0.0015% of current range, minimum 0.3 fA
- Current measurement accuracy: 0.2% if $\geq 1e-6$ A/V, 1% otherwise
- Input bias current: < 10 pA

Galvanostat:

- Galvanostat applied current range: 3 nA – 10 mA
- Applied current resolution: 0.03% of applied current range

Electrometer:

- Reference electrode input impedance: 1e12 ohm
- Reference electrode input bias current: ≤ 10 pA @ 25°C

Waveform Generation and Data Acquisition:

- Fast waveform update: 1 MHz @ 16-bit
- Fast data acquisition: 16-bit ADC, 1,000,000 samples/sec
- External signal recording channel

Experimental Parameters:

- CV and LSV scan rate: 0.000001 to 5000 V/s
- CA and CC pulse width: 0.0001 to 1000 sec
- CA minimum sample interval: 1 μ s
- CC minimum sample interval: 1 μ s
- True integrator for CC
- DPV and NPV pulse width: 0.001 to 10 sec
- SWV frequency: 1 to 100 kHz
- i-t sample interval: minimum 1 μ s
- ACV frequency: 0.1 to 10 kHz
- SHACV frequency: 0.1 to 5 kHz

Other Features:

- Automatic and manual iR compensation
- External potential input
- Potential and current analog output
- Programmable potential filter
- Programmable signal filter
- RDE control output (Model 840D and up): 0-10V (corresponding to 0-10000 rpm), 16-bit, 0.003% accuracy
- Flash memory for quick software update
- USB port for data communication
- Cell control: purge, stir, knock
- Maximum data length: 256K-16384K selectable
- CV simulation and fitting program, user defined mechanisms
- Dimension: 14.25"(W) \times 9.25"(D) \times 4.75"(H)
- Weight: 12 lb.

Differences of 800D Series Models

Functions	800D/802D	810D/812D	820D/822D	830D/832D	840D/842D	850D/852D
Cyclic Voltammetry (CV)*	•	•	•	•	•	•
Linear Sweep Voltammetry (LSV) &*	•	•	•	•	•	•
Staircase Voltammetry (SCV) #,&*						•
Tafel Plot (TAFEL)						•
Chronoamperometry (CA)*				•	•	•
Chronocoulometry (CC)				•	•	•
Differential Pulse Voltammetry (DPV) #,&*			•	•	•	•
Normal Pulse Voltammetry (NPV) #,&*			•	•	•	•
Differential Normal Pulse Voltammetry (DNPV) #,&						•
Square Wave Voltammetry (SWV) &*			•	•	•	•
AC Voltammetry (ACV) #,&S						•
2nd Harmonic AC Voltammetry (SHACV) #,&S						•
Amperometric i-t Curve (i-t)*	•	•		•	•	•
Differential Pulse Amperometry (DPA)		•		•	•	•
Double Differential Pulse Amperometry (DDPA)		•		•	•	•
Triple Pulse Amperometry (TPA)		•		•	•	•
Integrated Pulse Amperometric Detection (IPAD)						•
Bulk Electrolysis with Coulometry (BE)			•	•	•	•
Hydrodynamic Modulation Voltammetry (HMV)						•
Sweep-Step Functions (SSF)					•	•
Multi-Potential Steps (STEP)					•	•
Chronopotentiometry (CP)					•	•
Chronopotentiometry with Current Ramp (CPCR)					•	•
Multi-Current Steps (ISTEP)					•	•
Potentiometric Stripping Analysis (PSA)				•	•	•
Electrochemical Noise Measurement (ECN)						•
Open Circuit Potential - Time	•	•	•	•	•	•
Galvanostat					•	•
RDE control (0-10V output)					•	•
Full version of CV simulator				•	•	•
Limited version of CV simulator	•	•	•			
iR Compensation	•	•	•	•	•	•
External Potential Input	•	•	•	•	•	•
Auxiliary Signal Measurement Channel	•	•	•	•	•	•

#: Corresponding polarographic mode can be performed.
 &: Corresponding stripping mode can be performed.
 #: Second channel (bipotentiostat) mode can be performed.

Model 920D Scanning Electrochemical Microscope

The scanning electrochemical microscope (SECM) was introduced in 1989¹ as an instrument that could examine chemistry at high resolution near interfaces. By detecting reactions that occur at a small electrode (the tip) as it is scanned in close proximity to a surface, the SECM can be employed to obtain chemical reactivity images of surfaces and quantitative measurements of reaction rates. Numerous studies with the SECM have now been reported from a number of laboratories all over the world, and the instrument has been used for a wide range of applications, including studies of corrosion, biological systems (e.g., enzymes, skin, leaves), membranes, and liquid/liquid interfaces.² Trapping and electrochemical detection of single molecules with the SECM has also been reported.

The CHI920D Scanning Electrochemical Microscope consists of a digital function generator, a bipotentiostat, high resolution data acquisition circuitry, a three dimensional nanopositioner, and a sample and cell holder. Diagrams for the SECM and cell/sample holder are shown below. The three dimensional nanopositioner has a spatial resolution down to nanometers but it allows a maximum traveling distance of 50 millimeters. The potential control range of the bipotentiostat is ± 10 V and the current range is ± 250 mA. The instrument is capable of measuring current down to sub-picoamperes.

In addition to SECM imaging, other modes of operation are available for scanning probe applications: Probe Scan Curve, Probe Approach Curve, Surface Interrogation SECM, and Surface Patterned Conditioning. The Probe Scan Curve mode allows the probe to move in the X, Y, or Z direction while the probe and substrate potentials are controlled and currents are measured. The probe can be stopped when the current reaches a specified level. This is particularly useful in searching for an object on the surface and determining approach curves. The Probe Approach Curve mode allows the probe to approach the surface of the substrate. It is also very useful in distinguishing the surface process, using PID control. The step size is automatically adjusted to allow fast surface approach, without letting the probe touch the surface. Surface Patterned Conditioning allows user to edit a pattern for surface conditioning by controlling the tip at two different potentials and durations. Constant height, constant current, potentiometric, and impedance modes are available for SECM imaging and probe scan curve.

The 920D is designed for scanning electrochemical microscopy, but many conventional electrochemical techniques are also integrated for convenience, such as CV, LSV, CA, CC, DPV, NPV, SWV, ACV, SHACV, FTACV, i-t, DPA, DDPA, TPA, SSF, STEP, IMP, IMPE, IMPT, and CP. When it is used as a bipotentiostat, the second channel can be controlled at an independent constant potential, to scan or step at the same potential as the first channel, or to scan with a constant potential difference with the first channel. The second channel works with CV, LSV, CA, DPV, NPV, DNPV, SWV, and i-t.

The 920D SECM is an upgrade to the 900/910B/920C SECM. The 920D uses a stepper motor positioner in conjunction with a closed-loop 3-dimensional piezo positioner. The stepper motor positioner has a resolution of 8 nanometers with 50 mm travel distance. Closed-loop piezo control allows improved linearity and reduced hysteresis of the piezo devices. Improvements include very stable and accurate potential and current control, and dual-channel data acquisition at high speed (1 MHz with 16-bit resolution).

1. A. J. Bard, F.-R. F. Fan, J. Kwak, and O. Lev, *Anal. Chem.* **61**, 132 (1989); U.S. Patent No. 5,202,004 (April 13, 1993).
2. A. J. Bard, F.-R. Fan, M. V. Mirkin, in *Electroanalytical Chemistry*, A. J. Bard, Ed., Marcel Dekker, New York, 1994, Vol. 18, pp 243-373.

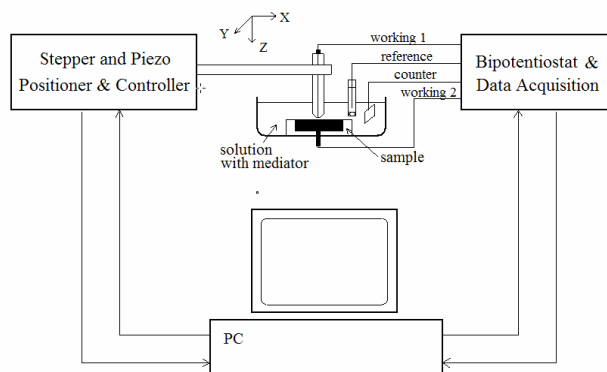
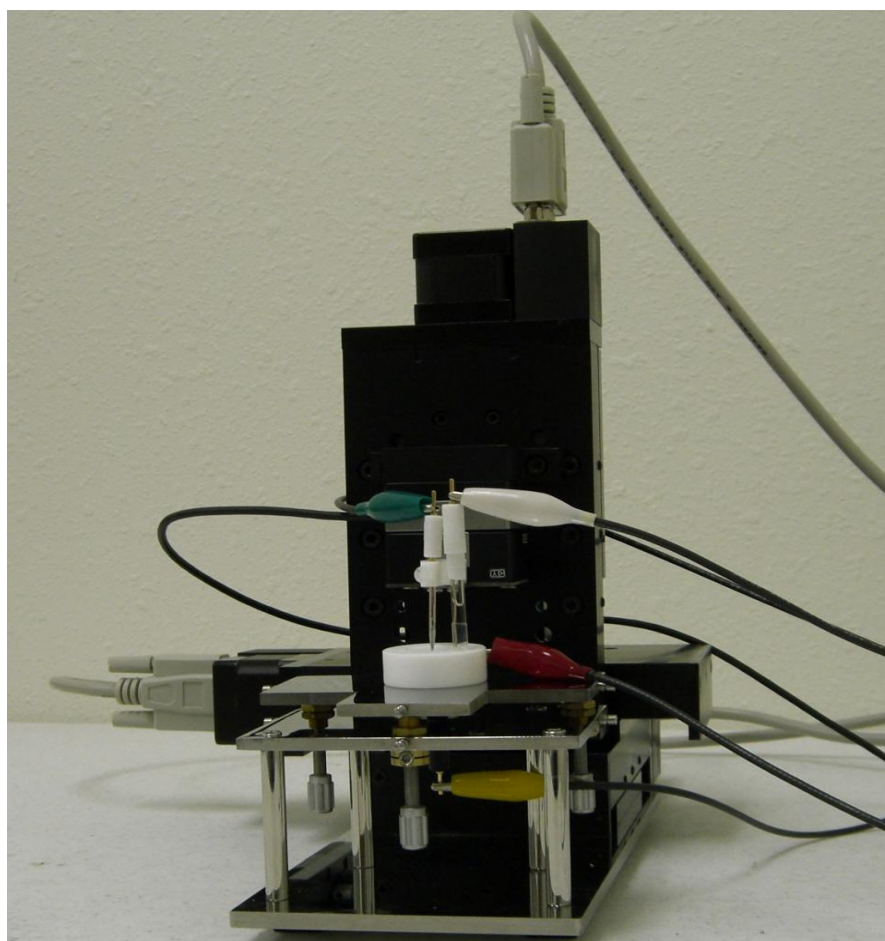

Diagram of Scanning Electrochemical Microscope



Bipotentiostat (Upper) and Positioner Controller (Lower)



Cell/Sample Holder

CHI920D SECM Specifications

Nanopositioner:

- X, Y, Z resolution: 1.6 nm with Piezo positioner, closed loop control, 8 nm with stepper motor positioner
- X, Y, Z total distance: 50 mm

Potentiostat / Bipotentiostat:

- Zero resistance ammeter
- 2- or 3- or 4-electrode configuration
- Floating (isolated from earth) or earth ground
- Maximum potential: ± 10 V for both channels
- Maximum current: ± 250 mA continuous (sum of two current channels), ± 350 mA peak
- Compliance Voltage: ± 13 V
- Potentiostat rise time: $< 1 \mu\text{s}$, $0.8 \mu\text{s}$ typical
- Potentiostat bandwidth (-3 dB): 1 MHz
- Applied potential ranges: ± 10 mV, ± 50 mV, ± 100 mV, ± 650 mV, ± 3.276 V, ± 6.553 V, ± 10 V
- Applied potential resolution: 0.0015% of potential range
- Applied potential accuracy: ± 1 mV, $\pm 0.01\%$ of scale
- Applied potential noise: $< 10 \mu\text{V}$ rms
- Measured current range: ± 10 pA to ± 0.25 A in 12 ranges
- Measured current resolution: 0.0015% of range, minimum 0.3 fA
- Measured current accuracy: 0.2% if range $\geq 1\text{e-}6$ A/V, else 1%
- Input bias current: < 20 pA

Galvanostat:

- Galvanostat applied current range: 3 nA – 250 mA
- Applied current accuracy: $20 \text{ pA} \pm 0.2\%$ if $> 3\text{e-}7$ A, else $\pm 1\%$
- Applied current resolution: 0.03% of applied current range
- Measured potential range (V): ± 0.025 , ± 0.1 , ± 0.25 , ± 1 , ± 2.5 , ± 10
- Measured potential resolution: 0.0015% of measured range

Electrometer:

- Reference electrode input impedance: $1\text{e}12$ ohm
- Reference electrode input bandwidth: 10 MHz
- Reference electrode input bias current: ≤ 10 pA @ 25°C

Waveform Generation and Data Acquisition:

- Fast waveform update: 10 MHz @ 16-bit
- Fast data acquisition: dual channel 16-bit ADC, 1,000,000 samples/sec simultaneously
- External signal recording channel at max 1 MHz sampling rate

2D and 3D Graphics:

- Interactive visualization of SECM surfaces
- Color mapping
- Laplacian smoothing
- Stereoscopic 3D anaglyph imaging
- High compatibility (Windows 7, 10)

Other Features:

- Software tilt adjustment on XY Plane for probe scan and imaging
- Automatic and manual iR compensation
- Current measurement bias: full range with 16-bit resolution, 0.003% accuracy
- Potential measurement bias: ± 10 V with 16-bit resolution, 0.003% accuracy
- External potential input
- Potential and current analog output
- Programmable potential and filter cutoffs: 1.5 MHz, 150 KHz, 15 KHz, 1.5 KHz, 150 Hz, 15 Hz, 1.5 Hz, 0.15 Hz
- RDE control output: 0-10V (corresponding to 0-10000 rpm), 16-bit, 0.003% accuracy
- Digital input/output lines programmable through macro command
- USB port for data communication
- Cell control: purge, stir, knock
- Maximum data length: 256K-16384K selectable
- Real Time Absolute and Relative Distance Display
- Real Time Probe and Substrate Current Display
- Dual-channel mode: CV, LSV, CA, DPV, NPV, SWV, i-t
- CV simulation and fitting program, user defined mechanisms
- Impedance simulation and fitting program

Techniques

Scanning Probe Techniques:

- SECM Imaging (SECM): constant height, constant current, potentiometric and impedance modes
- Probe Approach Curves (PAC)
- Probe Scan Curve (PSC): constant height, constant current, potentiometric, impedance, and constant impedance modes
- Surface Patterned Conditioning (SPC)
- Surface Interrogation SECM (SISECM)
- Z Probe Constant Current Control

Sweep Techniques:

- Cyclic Voltammetry (CV)
- Linear Sweep Voltammetry (LSV)
- Tafel Plot (TAFEL)

Step and Pulse Techniques:

- Staircase Voltammetry (SCV)
- Chronoamperometry (CA)
- Chronocoulometry (CC)
- Differential Pulse Voltammetry (DPV)
- Normal Pulse Voltammetry (NPV)
- Differential Normal Pulse Voltammetry (DNPV)
- Square Wave Voltammetry (SWV)

AC Techniques:

- AC Voltammetry (ACV)
- Second Harmonic AC Voltammetry (SHACV)
- Fourier Transform AC Voltammetry (FTACV)
- AC Impedance (IMP)
- Impedance versus Potential (IMPE)
- Impedance versus Time (IMPT)

Galvanostatic Techniques:

- Chronopotentiometry (CP)
- Chronopotentiometry with Current Ramp (CPCR)
- Multi-Current Steps (ISTEP)
- Potentiometric Stripping Analysis (PSA)

Other Techniques:

- Amperometric i-t Curve (i-t)
- Differential Pulse Amperometry (DPA)
- Double Differential Pulse Amperometry (DDPA)
- Triple Pulse Amperometry (TPA)
- Integrated Pulse Amperometric Detection (IPAD)
- Bulk Electrolysis with Coulometry (BE)
- Hydrodynamic Modulation Voltammetry (HMV)
- Sweep-Step Functions (SSF)
- Multi-Potential Steps (STEP)
- Electrochemical Noise Measurement (ECN)
- Open Circuit Potential - Time (OCPT)
- Various Stripping Voltammetry
- Potentiometry

Experimental Parameters:

- CV/LSV scan rate: 0.000001 to 10,000 V/s, two channels simultaneously
- Potential increment during scan: 0.1 mV @ 1,000 V/s
- CA and CC pulse width: 0.0001 to 1000 sec
- CA minimum sample interval: 1 μs , both channels
- CC minimum sample interval: 1 μs
- True integrator for CC
- DPV and NPV pulse width: 0.001 to 10 sec
- SWV frequency: 1 to 100 kHz
- i-t sample interval: minimum 1 μs , both channel
- ACV frequency: 0.1 to 10 kHz
- SHACV frequency: 0.1 to 5 kHz
- FTACV frequency: 0.1 to 50 Hz, simultaneous acquire 1st, 2nd, 3rd, 4th, 5th, and 6th harmonics ACV data
- IMP frequency: 0.00001 to 1 MHz
- IMP amplitude: 0.00001 V to 0.7 V RMS

Principles and Applications of SECM

I. Operational Principles of SECM

As in other types of scanning probe microscopes, SECM is based on the movement of a very small electrode (the tip) near the surface of a conductive or insulating substrate.¹ In amperometric SECM experiments, the tip is usually a conventional ultramicroelectrode (UME) fabricated as a conductive disk of metal or carbon in an insulating sheath of glass or polymer. Potentiometric SECM experiments with ion-selective tips are also possible.²

In amperometric experiments, the tip current is perturbed by the presence of the substrate. When the tip is far (i.e. greater than several tip diameters) from the substrate, as shown in Fig. 1A, the steady-state current, $i_{T,\infty}$, is given by

$$i_{T,\infty} = 4nFDca$$

where F is Faraday's constant, n is the number of electrons transferred in the tip reaction ($O + ne \rightarrow R$), D is the diffusion coefficient of species O , C is the concentration, and a is the tip radius. When the tip is moved toward the surface of an insulating substrate, the tip current, i_T , decreases because the insulating sheath of the tip blocks diffusion of O to the tip from the bulk solution. The closer the tip gets to the substrate, the smaller i_T becomes (Fig 1B). On the other hand, with a conductive substrate, species R can be oxidized back to O . This produces an additional flux of O to the tip and hence an increase in i_T (Fig. 1C). In this case, the smaller the value of d , the larger i_T will be, with $i_T \rightarrow \infty$ as $d \rightarrow 0$, assuming the oxidation of R on the substrate is diffusion-limited. These simple principles form the basis for the feedback mode of SECM operation.

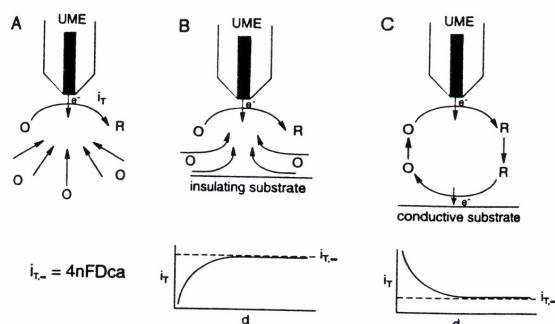

Figure 1. Operating principles of SECM. (A). With UME far from the substrate, diffusion of O leads to a steady-state current, $i_{T,\infty}$; (B). With the UME placed near an insulating substrate, hindered diffusion of O leads to $i_T < i_{T,\infty}$; (C). with UME near a conductive substrate, positive feedback of O leads to $i_T > i_{T,\infty}$.

When the tip is rastered in the x - y plane above the substrate, the tip current variation represents changes in topography or conductivity (or reactivity). One can separate topographic effects from conductivity effects by noting that over an insulator i_T is always less than $i_{T,\infty}$, while over a conductor i_T is always greater than $i_{T,\infty}$.

In the feedback mode of the SECM operation as stated above, the overall redox process is essentially confined to the thin layer between the tip and the substrate. In the substrate-generation/tip-collection (SG/TC) mode (when the substrate is a generator and the tip is a collector), the tip travels within a thin diffusion layer generated by the substrate electrode.^{1b,3} There are some shortcomings which limit the applicability of the SG/TC mode if the substrate is large: (1). the process at a large substrate is always non-steady state; (2). a large substrate current may cause significant iR -drop; and (3). the collection efficiency, i.e., the ratio of the tip current to the substrate current, is low. The tip-generation/substrate-collection (TG/SC) mode is advisable for kinetic measurements, while SG/TC can be used for monitoring enzymatic reactions, corrosion, and other heterogeneous processes at the substrate surface.

II. Applications

A. Imaging and positioning

A three-dimensional SECM image is obtained by scanning the tip in the x - y plane and monitoring the tip

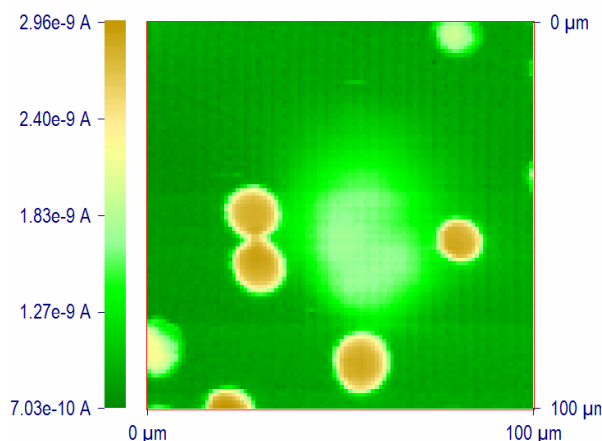

Figure 2. SECM image of a polycarbonate filtration membrane with a 2- μ m-diameter Pt disk UME in $Fe(CN)_6^{4-}$ solution. Average pore diameter is ca. 10 μ m.

current, i_T , as a function of tip location. A particular advantage of SECM in imaging applications, compared to other types of scanning probe microscopy, is that the response observed can be interpreted based on fairly rigorous theory, and hence the measured current can be employed to estimate the tip-substrate distance. Moreover, SECM can be used to image the surfaces of different types of substrates, both conductors and insulators, immersed in solutions. The resolution attainable with SECM depends upon the tip radius. For example, Fig. 2 shows one SECM image of a filtration membrane obtained with a 2- μm -diameter Pt disk tip in $\text{Fe}(\text{CN})_6^{4-}$ solution. Average pore diameter is ca. 10 μm . An image demonstrating the local activity of an enzymatic reaction on a filtration membrane is shown in Fig. 9 as described below.

B. Studies of heterogeneous electron transfer reactions

SECM has been employed in heterogeneous kinetic studies on various metal, carbon and semiconductor substrates.⁴ In this application, the x-y scanning feature of SECM is usually not used. In this mode, SECM has many features of UME and thin layer electrochemistry with a number of advantages. For example, the characteristic flux to an UME spaced a distance, d , from a conductive substrate is of the order of DC/d , independent of the tip radius, a , when $d < a$. Thus, very high fluxes and thus high currents can be obtained. For example, the measurement of the very fast kinetics

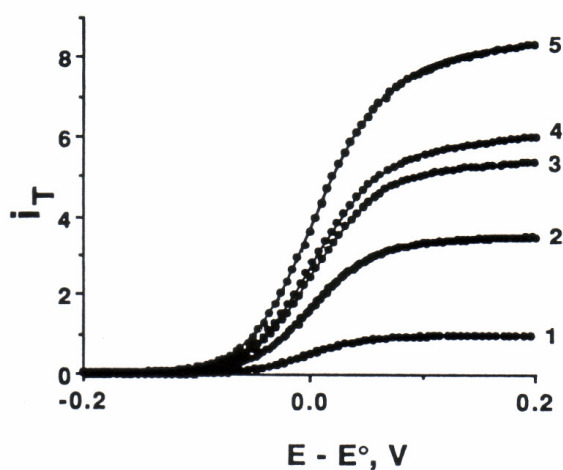

Figure 3. Tip steady-state voltammograms for the oxidation of 5.8 mM ferrocene in 0.52 M TBABF_4 in MeCN at a 1.1- μm -radius Pt tip. Solid lines are theoretical curves and solid circles are experimental data. Tip-substrate separation decreases from 1 to 5 ($d/a = \infty, 0.27, 0.17, 0.14,$ and 0.1). (Reprinted with permission from Ref. 4e, copyright 1993, American Chemical Society.)

Of the oxidation of ferrocene at a Pt UME has been carried out.^{4e} Five steady-state voltammograms obtained at different distances are shown in Fig. 3, along with the theoretical curves calculated with the values of the kinetic parameters extracted from the quartile potentials. The heterogeneous rate constant, k^0 , obtained ($3.7 \pm 0.6 \text{ cm/sec}$) remains constant within the range of experimental error, while the mass-transfer rate increases with a decrease in d .

C. Studies of homogeneous chemical reactions

As mentioned above, the TG/SC (with small tip and substrate) mode of SECM, in the same manner as the rotating ring disk electrode (RRDE), is particularly suitable for the studies of homogeneous chemical kinetics.^{1b,5} The SECM approach has the advantage that different substrates can be examined easily, i.e., without the need to construct rather difficult to fabricate RRDEs, and higher interelectrode fluxes are available without the need to rotate the electrode or otherwise cause convection in the solution. Moreover, in the TG/SC mode, the collection efficiency in the absence of perturbing homogeneous chemical reaction is near 100%, compared to significantly lower values in practical RRDEs. Finally, although transient SECM measurements are possible, most applications have involved steady-state currents, which are easier to measure and are not perturbed by factors like double-layer charging and also allow for signal averaging. For example, the reductive coupling of both dimethylfumarate (DF) and fumaronitrile (FN) in N,N -dimethylformamide has been studied with the TG/SC mode.^{5a} Fig. 4 shows tip and substrate steady-state voltammograms for the TG/SC regime. Comparable values of both of the plateau currents indicated that the mass

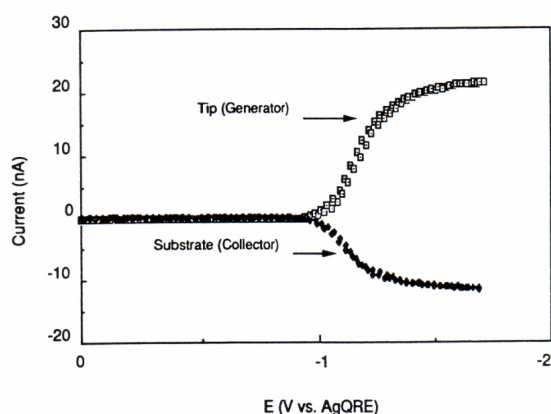

Figure 4. SECM voltammograms for FN (28.2 mM) reduction in TG/SC mode. $d = 1.8 \mu\text{m}$. E_T was scanned at 100 mV/sec with $E_S = 0.0 \text{ V vs AgQRE}$. (Reprinted with permission from Ref. 5a, copyright 1992, American Chemical Society.)

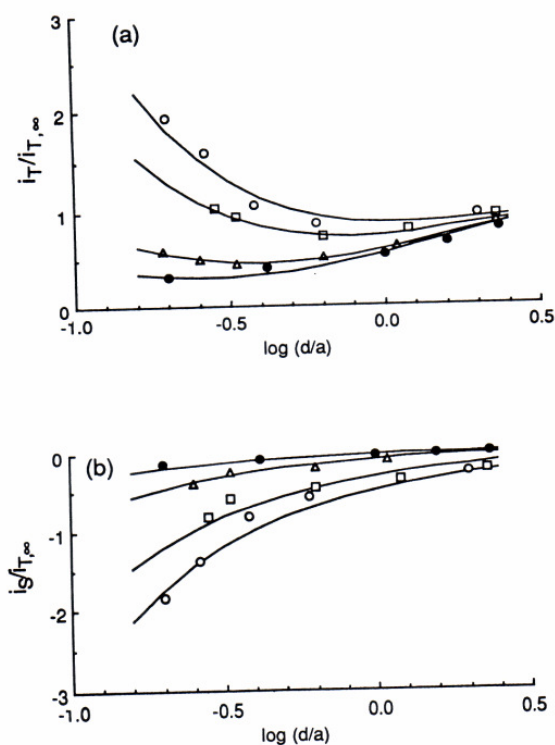

Figure 5. Normalized tip (generation, A) and substrate (collection, B) current-distance behavior for FN reduction. FN concentration: (open circle) 1.50 mM, (open square) 4.12 mM, (open triangle) 28.2 mM, and (filled circle) 121 mM. $a = 5 \mu\text{m}$, substrate radius is $50 \mu\text{m}$. The solid lines represent the best theoretical fit for each set of data. (Reprinted with permission from Ref. 5a, copyright 1992, American Chemical Society.)

transfer rate was sufficiently fast to study the rapid homogeneous reaction. From the approach curves of both tip and substrate currents (Fig. 5) obtained at various FN concentrations, a rate constant $k_c = 2.0 (\pm 0.4) \times 10^5 \text{ M}^{-1}\text{s}^{-1}$ was determined for the dimerization reactions.

D. Characterization of thin films and membranes

SECM is also a useful technique for studying thin films on interfaces. Both mediated and direct electrochemical measurements in thin films or membranes can be carried out. For example, polyelectrolytes, electronically conductive polymers, passivation films on metals and dissolution processes have been investigated by SECM.⁶ A unique type of cyclic voltammetry, called tip-substrate cyclic voltammetry (T/S CV), has been used to investigate the

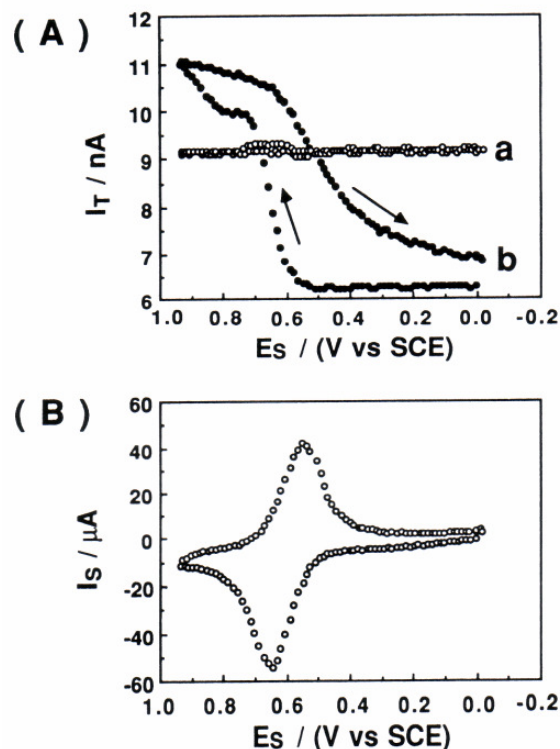

Figure 6. T/S CVs (A) curve a, $d = 500 \mu\text{m}$, and substrate CV (B) on Nafion/Os(bpy)₃^{3+/2+} electrode in $\text{K}_3\text{Fe}(\text{CN})_6/\text{Na}_2\text{SO}_4$, scan rate = 50 mV/sec, $E_T = -0.4 \text{ V vs. SCE}$. (Reprinted with permission from Ref. 6a, copyright 1990, American Chemical Society.)

electrochemical behavior of an Os(bpy)₃²⁺-incorporated Nafion film.^{6a} T/S CV involves monitoring the tip current vs. the substrate potential (E_S) while the tip potential (E_T) is maintained at a given value and the tip is held near the substrate. The substrate CV (i_S vs. E_S) of an Os(bpy)₃²⁺-incorporated Nafion film covering a Pt disk electrode in $\text{Fe}(\text{CN})_6^{3-}$ solution only shows a wave for the Os(bpy)₃^{2+/3+} couple (Fig. 6B), indicating the permselectivity of the Nafion coating. Fig. 6A shows the corresponding T/S CV curves. When the tip is far from the substrate, i_T is essentially independent of E_S . When the tip is close to the substrate ($d = 10 \mu\text{m}$), either negative or positive feedback effects are observed, depending on the oxidation state of the Os(bpy)₃^{2+/3+} couple in the Nafion. When E_S is swept positive of the Os(bpy)₃^{2+/3+} redox wave, a positive feedback effect is observed due to the regeneration of $\text{Fe}(\text{CN})_6^{3-}$ in the solution gap region because of the oxidation of $\text{Fe}(\text{CN})_6^{4-}$ by Os(bpy)₃³⁺ at the solution-film interface. When E_S is negative of the redox wave, the film shows negative feedback behavior, since the

Os(bpy)₃²⁺ formed is unable to oxidize tip-generated

$\text{Fe}(\text{CN})_6^{4-}$ back to $\text{Fe}(\text{CN})_6^{3-}$.

E. Liquid-liquid interfaces

One of the most promising applications of SECM is the study of charge transport at the interface between two immiscible electrolyte solution (ITIES).⁷ Unlike conventional techniques, SECM allows for the studies of both ion and electron transfer at the interface. For example, uphill electron transfer, in which an electron is transferred uphill from a redox couple with a higher standard reduction potential in one phase to another redox couple having a lower standard reduction potential in a second immiscible phase has been demonstrated using the system TCNQ (in 1,2-dichloroethane (DCE))/ferrocyanide (in water).^{7c} Fig. 7 shows the approach curve obtained as the UME approaches the interface when the system contains supporting electrolytes with no partitioning ions such as tetraphenylarsonium (TPAs^+). However, the reverse electron flow for the same redox reaction can be induced by employing TPAs^+ as a potential-determining ion as shown in Fig. 8. The driving force for this reverse electron transfer is the imposition of an interfacial potential difference by the presence in solution of TPAs^+ in both phases ($\Delta_0^w\phi = -364$ mV). Note that the detection of reverse electron flow in this case could not be done using the method commonly used for studies of the ITIES, e.g., cyclic voltammetry.

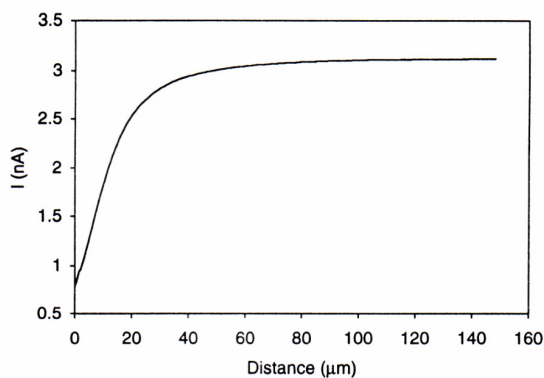

Figure 7. Approach curve for the system: 10 mM TCNQ and 1 mM TPAsTPB in DCE // 1 mM $\text{Fe}(\text{CN})_6^{3-}$ and 0.1 M LiCl in H_2O , showing the absence of electron transfer across the liquid/liquid interface. A 25- μm -diameter Pt microelectrode was used to generate $\text{Fe}(\text{CN})_6^{4-}$ at the electrode tip from the $\text{Fe}(\text{CN})_6^{3-}$. Tip potential, -0.4 V vs Ag/AgCl. (Reprinted with permission from Ref. 7c, copyright 1995, American Chemical Society.)

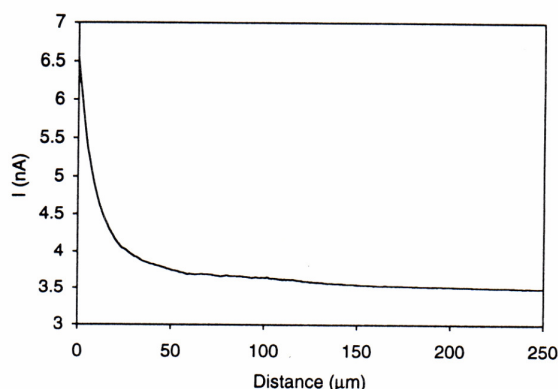

Figure 8. Approach curve for the system: 10 mM TCNQ and 1 mM TPAsTPB in DCE // 1 mM $\text{Fe}(\text{CN})_6^{3-}$, 0.1 M LiCl and 1 mM TPAsCl in H_2O , showing reverse electron transfer driven by phase transfer catalyst TPAs^+ . Tip potential, -0.4 V vs Ag/AgCl. (Reprinted with permission from Ref. 7c, copyright 1995, American Chemical Society.)

Since the ITIES is not polarizable in the presence of TPAs^+ in both phases, any attempt to impose externally a potential across the interface with electrodes in two phases would result in interfacial ion transfer and a current flow. The SECM approach does not suffer from this interference. Charge transfer processes across the ITIES with or without membranes have also been studied.

F. Probing patterned biological systems

SECM has been actively employed to probe artificially or naturally patterned biological systems.⁸ Both amperometric and potentiometric techniques with ion-selective tips can be used. A direct test of the SECM's ability to image an enzymatic reaction over a localized surface region^{8a} is shown in Fig. 9. Glucose oxidase (GO) hydrogel was filled inside small, well-defined pores of polycarbonate filtration membranes. The buffered assay solution contained a high concentration of D-glucose as well as two redox mediators, methyl viologen dication (MV^{2+}) and neutral hydroquinone (H_2Q). Fig. 9a shows an image obtained with a tip potential of -0.95 V vs. a silver quasi reference electrode (AgQRE) where MV^{2+} was reduced to MV^+ . Since MV^+ does not react with reduced GO at the hydrogel-filled region, a negative feedback current was obtained. However, with the tip potential changed to 0.82 V, where hydroquinone was oxidized to p-benzoquinone by reduced GO, an increased tip current was observed (Fig. 9b). This positive feedback current over the hydrogel region indicates a significant catalytic feedback of the hydroquinone and provides a direct image of the local enzymatic reaction.

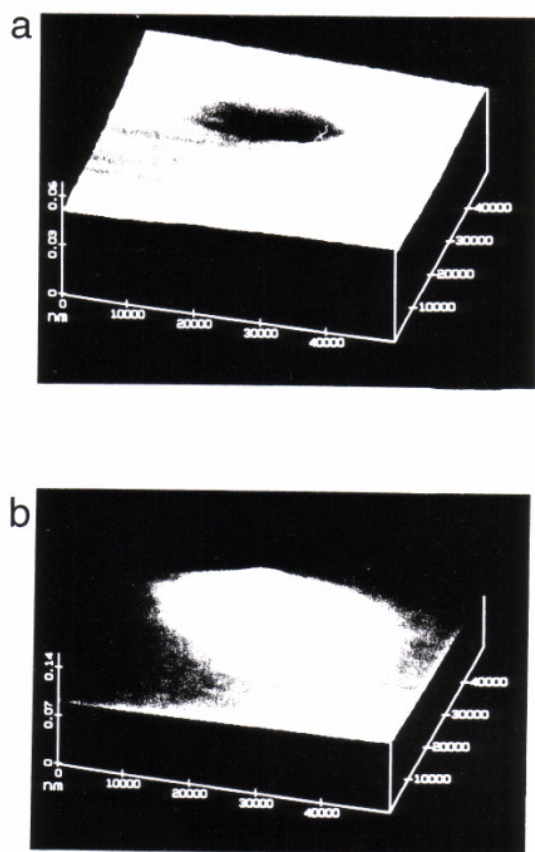

Figure 9. SECM images ($50\ \mu\text{m} \times 50\ \mu\text{m}$) of a single GO hydrogel-filled pore on the surface of a treated membrane. Images were taken with a carbon microelectrode tip ($a = 4.0\ \mu\text{m}$). (a). Negative feedback with MV^{2+} mediator at tip potential $-0.95\ \text{V}$ vs AgQRE. (b). Positive feedback with hydroquinone mediator at tip potential $+0.82\ \text{V}$ vs AgQRE in $0.1\ \text{M}$ phosphate-perchlorate buffer (pH 7.0) containing $100\ \text{mM}$ D-glucose, $50\ \mu\text{M}$ hydroquinone and $0.1\ \text{mM}$ MVCl_2 . Lightest image regions depict the greatest tip current. (Reprinted with permission from Ref. 8a, copyright 1993, American Chemical Society.)

G. Fabrication

The SECM can be used to fabricate microstructures on surfaces by deposition of metal or other solids or by etching of the substrate.⁹ Two different approaches have been used, the direct mode^{9a,b} and the feedback mode^{9c}. Typically, in the direct mode, the tip, held in close proximity to the substrate, acts as a working

electrode (in deposition reactions) or as the counterelectrode (in etching processes). The feedback mode of fabrication utilizes the same arrangement as in SECM imaging.

The tip reaction is selected to generate a species that reacts at the substrate to promote the desired reaction, i.e., deposition or etching. For example, a strong oxidant, like Br_2 , generated at the tip can etch the area of the substrate, e.g., GaAs, directly beneath the tip.^{9d} The mediator reactant is chosen to be one that reacts completely and rapidly at the substrate, thus confining the reaction to a small area on the substrate and producing features of area near that of the tip. Small tip size and close tip-substrate spacing are required for high resolution.

III. References

- (a). A. J. Bard, F.-R. F. Fan, J. Kwak, and O. Lev, *Anal. Chem.* **1989**, *61*, 132; (b). A. J. Bard, F.-R. F. Fan, and M. V. Mirkin in *Electroanalytical Chemistry*, Vol.18 (A. J. Bard, ed.), Marcel Dekker, New York, 1994, p. 243.
- e.g., (a). For a review of early potentiometric SECM experiments, see Ref. 1b; (b). C. Wei, A. J. Bard, G. Nagy, and K. Toth, *Anal. Chem.* **1995**, *67*, 1346; (c). K. Toth, G. Nagy, C. Wei, and A. J. Bard, *Electroanal.* **1995**, *7*, 801; (d). M. Kupper and J. W. Schultze, *Fres. J. Anal. Chem.* **1996**, *356*, 187.
- See also (a). R. C. Engstrom, M. Weber, D. J. Wunder, R. Burgess, and S. Winquist, *Anal. Chem.* **1986**, *58*, 844; (b). R. C. Engstrom, T. Meaney, R. Tople, and R. M. Wightman, *Anal. Chem.* **1987**, *59*, 2005.
- e.g., (a). D. O. Wipf and A. J. Bard, *J. Electrochem. Soc.* **1991**, *138*, 469; (b). B. R. Horrocks, M. V. Mirkin, and A. J. Bard, *J. Phys. Chem.* **1994**, *98*, 9106; (c). R. S. Hutton and D. E. Williams, *Electrochim. Acta*, **1994**, *39*, 701; (d). N. Casillas, P. James, and W. H. Smyrl, *J. Electrochem. Soc.* **1995**, *142*, L16; (e). M. V. Mirkin, T. C. Richards, and A. J. Bard, *J. Phys. Chem.* **1993**, *97*, 7672; (f). M. V. Mirkin, L.O.S. Bulhoes, and A. J. Bard, *J. Am. Chem. Soc.* **1993**, *115*, 201; (g). J. V. Macpherson, M. A. Beeston, and P. R. Unwin, *J. Chem. Soc. Faraday Trans.* **1995**, *91*, 899.
- e.g., (a). F. M. Zhou, P. R. Unwin, and A. J. Bard, *J. Phys. Chem.* **1992**, *96*, 4917; (b). P.R. Unwin and A. J. Bard, *J. Phys. Chem.* **1991**, *95*, 7814; (c). F. M. Zhou and A. J. Bard, *J. Am Chem. Soc.* **1994**, *116*, 393; (d). D. A. Treichel, M. V. Mirkin, and A. J. Bard, *J. Phys. Chem.* **1994**, *98*, 5751; (e). C. Demaille, P. R. Unwin, and A. J. Bard, *J. Phys. Chem.* **1996**, *100*, 14137.

6. e.g., (a). C. Lee and A. J. Bard, *Anal. Chem.* **1990**, *62*, 1906; (b). C. Lee, J. Kwak, and F. C. Anson, *Anal. Chem.* **1991**, *63*, 1501; (c). J. Kwak, C. Lee, and A. J. Bard, *J. Electrochem. Soc.* **1990**, *137*, 1481; (d). C. Lee and F. C. Anson, *Anal. Chem.* **1992**, *64*, 250. (e). I. C. Jeon and F. C. Anson, *Anal. Chem.* **1992**, *64*, 2021; (f). M. V. Mirkin, F.-R. F. Fan, and A. J. Bard, *Science*, **1992**, *257*, 364. (g). M. Arca, M. V. Mirkin, and A. J. Bard, *J. Phys. Chem.* **1995**, *99*, 5040; (h). M. Pyo and A. J. Bard, *Electrochim. Acta* **1997**, *42*, 3077; (i). E. R. Scott, A. I. Laplaza, H. S. White, and J. B. Phipps, *Pharmaceut. Res.* **1993**, *10*, 1699; (j). S. R. Snyder and H. S. White, *J. Electroanal. Chem.* **1995**, *394*, 177; (k). S. B. Basame and H. S. White, *J. Phys. Chem.* **1995**, *99*, 16430; (l). N. Casillas, S. Charlebois, W. H. Smyrl, and H. S. White, *J. Electrochem. Soc.* **1994**, *141*, 636; (m). D. O. Wipf, *Colloid Surf. A*, **1994**, *93*, 251. (n). E. R. Scott, H. S. White, and J. B. Phipps, *Solid State Ionics* **1992**, *53*, 176; (o). S. Nugnes and G. Denuault, *J. Electroanal. Chem.* **1996**, *408*, 125; (p). M. H. T. Frank and G. Denuault, *J. Electroanal. Chem.* **1993**, *354*, 331; (q). J. V. Macpherson and P. R. Unwin, *J. Chem. Soc. Faraday Trans.* **1993**, *89*, 1883; (r). J. V. Macpherson and P. R. Unwin, *J. Phys. Chem.* **1994**, *98*, 1704; (s). J. V. Macpherson and P. R. Unwin, *J. Phys. Chem.* **1995**, *99*, 14824; **1996**, *100*, 19475; (t). J. V. Macpherson, C. J. Slevin, and P. R. Unwin, *J. Chem. Soc. Faraday Trans.* **1996**, *92*, 3799; (u). K. Borgwarth, C. Ricken, D. G. Ebling, and Heinze, *Ber. Bunsenges. Phys. Chem.* **1995**, *99*, 1421; (v). Y. Y. Zhu and D. E. Williams, *J. Electrochem. Soc.* **1997**, *144*, L43; (w). C. Jehoulet, Y. S. Obeng, Y. T. Kim, F. M. Zhou, and A. J. Bard, *J. Am. Chem. Soc.* **1992**, *114*, 4237; (x). E. R. Scott, H. S. White, and J. B. Phipps, *J. Membrane Sci.* **1991**, *58*, 71; (y). H. Sugimura, T. Uchida, N. Kitamura, and H. Masuhara, *J. Phys. Chem.* **1994**, *98*, 4352; (z). J. E. Vitt and R. C. Engstrom, *Anal. Chem.* **1997**, *69*, 1070.
7. e.g., (a). C. Wei, A. J. Bard, and M. V. Mirkin, *J. Phys. Chem.* **1995**, *99*, 16033; (b). T. Solomon and A. J. Bard, *J. Phys. Chem.* **1995**, *67*, 2787; (c). T. Solomon and A. J. Bard, *J. Phys. Chem.* **1995**, *99*, 17487; (d). Y. Selzer and D. Mandler, *J. Electroanal. Chem.* **1996**, *409*, 15; (e). M. Tsionsky, A. J. Bard, and M. V. Mirkin, *J. Phys. Chem.* **1996**, *100*, 17881; (f). C. J. Slevin, J. A. Umbers, J. H. Atherton, and P. R. Unwin, *J. Chem. Soc. Faraday Trans.* **1996**, *92*, 5177; (g). Y. H. Shao, M. V. Mirkin, and J. F. Rusling, *J. Phys. Chem. B* **1997**, *101*, 3202; (h). M. Tsionsky, A. J. Bard, and M. V. Mirkin, *J. Am. Chem. Soc.* **1997**, *119*, 10785; (i). M.-H. Delville, M. Tsionsky, and A. J. Bard, (submitted to *J. Am. Chem. Soc.* for publication).
8. e.g., (a). D. T. Pierce and A. J. Bard, *Anal. Chem.* **1993**, *65*, 3598; (b). B. R. Horrocks, D. Schmidtke, A. Heller, and A. J. Bard, *Anal. Chem.* **1993**, *65*, 3605; (c). H. Yamada, H. Shiku, T. Matsue, and I. Uchida, *Bioelectrochem. Bioenerg.* **1994**, *33*, 91; (d). B. Grundig, G. Wittstock, U. Rudel, and B. Strehlitz, *J. Electroanal. Chem.* **1995**, *395*, 143; (e). G. Wittstock, K. J. Yu, H. B. Halsall, T. H. Ridgway, and W. R. Heineman, *Anal. Chem.* **1995**, *67*, 3578; (f). H. Shiku, T. Matsue, and I. Uchida, *Anal. Chem.* **1996**, *68*, 1276; (g). J. L. Gilbert, S. M. Smith, and E. P. Lautenschlager, *J. Biomed. Mater. Res.* **1993**, *27*, 1357; (h). C. Kranz, T. Lotzbeyer, H. L. Schmidt, and W. Schuhmann, *Biosens. Bioelectron.* **1997**, *12*, 257; (i). C. Kranz, G. Wittstock, H. Wohlschlager, and W. Schuhmann, *Electrochim. Acta*, **1997**, *42*, 3105; (j). C. Lee, J. Kwak, and A. J. Bard, *Proc. Natl. Acad. Sci. U.S.A.* **1990**, *87*, 1740; (k). R. B. Jackson, M. Tsionsky, Z. G. Cardon, and A. J. Bard, *Plant Physiol.* **1996**, *112*, 354; (l). M. Tsionsky, Z. G. Cardon, A. J. Bard, and R. B. Jackson, *Plant Physiol.* **1997**, *113*, 895.
9. e.g., (a). C. W. Lin, F.-R. F. Fan, and A. J. Bard, *J. Electrochem. Soc.* **1987**, *134*, 1038; (b). D. H. Craston, C. W. Lin, and A. J. Bard, *J. Electrochem. Soc.* **1988**, *135*, 785; (c). D. Mandler and A. J. Bard, *J. Electrochem. Soc.* **1989**, *136*, 3143; (d). D. Mandler and A. J. Bard, *J. Electrochem. Soc.* **1990**, *137*, 2468; (e). O. E. Husser, D. H. Craston, and A. J. Bard, *J. Vac. Sci. Technol. B* **1988**, *6*, 1873; (f). Y.-M. Wu, F.-R. F. Fan, and A. J. Bard, *J. Electrochem. Soc.* **1989**, *136*, 885; (g). H. Sugimura, T. Uchida, N. Shimo, N. Kitamura, and H. Masuhara, *Ultramicroscopy* **1992**, *42*, 468; (h). I. Shohat and D. Mandler, *J. Electrochem. Soc.* **1994**, *141*, 995; (i). S. Meltzer and D. Mandler, *J. Chem. Soc. Faraday Trans.* **1995**, *91*, 1019; (j). C. Kranz, H. E. Gaub, and W. Schuhmann, *Advan. Mater.* **1996**, *8*, 634; (k). J. F. Zhou and D. O. Wipf, *J. Electrochem. Soc.* **1997**, *144*, 1202.

Model 1000C Series Multi-Potentiostat

The model 1000C series is a computerized eight-channel potentiostat. The system contains a digital function generator and multiplexed data acquisition circuitry. The multi-potentiostat allows eight working electrodes in a same solution with a common reference electrode and a common counter electrode. It also allows eight independent cells with a working electrode, a reference electrode and a counter electrode in each cell. Multiple channels can be measured simultaneously or sequentially. However, they share a same set of experiment parameters. Each channel can be controlled at different independent but constant potentials and different sensitivities. Or the potentials of 2-8 channels can be scanned or stepped together with the primary channel with the same set of parameters. You can not run channel 1 first and ask channel 2 to run while channel 1 is still running. You can not scan channel 1 at a potential range, but channel 2 at a different potential range. They all have to run the same time with a same set of experimental time scale.

It is designed mainly for electrochemical sensor studies. The potential control range is ± 10 V for all channels and the current range is ± 10 mA. The instrument is capable of measuring current down to picoamperes. Each electrode can be individually controlled, including on/off control, potential, and sensitivity settings; each can be set to an independent potential or the same potential as the primary channel, so that they can sweep or step potentials together with the primary channel.

The model 1000C series is an upgrade to the model 1000/1000A/1000B series. The instrument allows eight independent cells, simultaneous or sequential measurements, fast waveform generation and data acquisition speed (1M Hz @ 16-bit), and easy software update using flash memory.

Many electrochemical techniques are available in the 1000C series, including cyclic voltammetry and amperometric i-t measurements, with all eight channels available (except for open circuit potential measurements). The parameters for all channels must be set before running an experiment; you cannot alter parameter settings during experiments. During a run, you can toggle between single and multi-data set display (parallel or overlay plots). After a run, you can choose data from any channel for parallel or overlay plotting.

The instrument can be controlled by an external PC running Windows 7/10. It is easy to install and use. The instrument connects to your PC using USB. The commands, parameters, and options have been written using terminology that most chemists are familiar with. A customizable toolbar allows quick access to the most commonly used commands. A comprehensive help system provides context-sensitive information from each dialog box.

The instrument provides many powerful functions, such as straightforward file handling, extensive experimental control, flexible graphics, various data analyses, and efficient digital simulation. Additional features include macro commands, working electrode conditioning, color, legend and font selection, data interpolation, visual baseline correction, data point removal, visual data point modification, signal averaging, Fourier spectrum, and a convenient technique-specific electrochemical equation viewer. The maximum data length is 128K – 8192K points (selectable) if real-time data transfer is allowed.

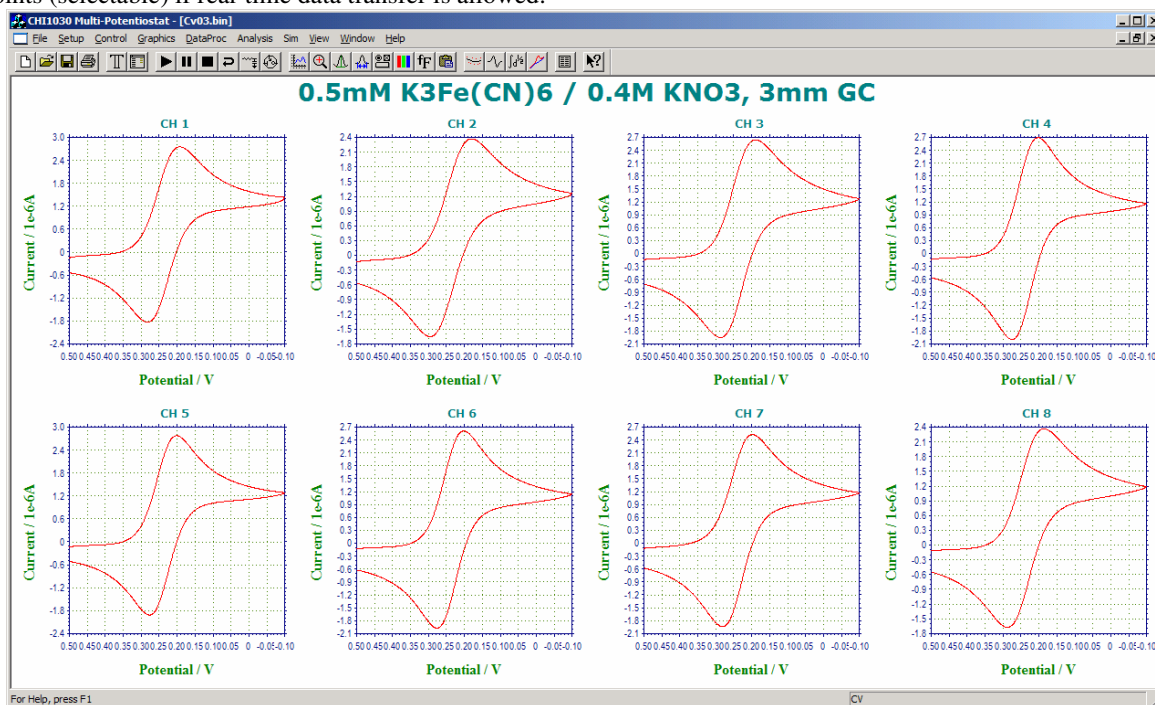

Differences of 1000C Series Models

Functions	1000C	1010C	1020C	1030C	1040C
Cyclic Voltammetry (CV)	●	●	●	●	●
Linear Sweep Voltammetry (LSV) &	●	●	●	●	●
Chronoamperometry (CA)				●	●
Chronocoulometry (CC)				●	●
Differential Pulse Voltammetry (DPV) &			●	●	●
Normal Pulse Voltammetry (NPV) &			●	●	●
Square Wave Voltammetry (SWV) &			●	●	●
AC Voltammetry (ACV) &					●
2nd Harmonic AC Voltammetry (SHACV) &					●
Fourier Transform AC Voltammetry (FTACV)					●
Amperometric i-t Curve (i-t)	●	●		●	●
Differential Pulse Amperometry (DPA)		●		●	●
Triple Pulse Amperometry (TPA)		●		●	●
Sweep-Step Functions (SSF)				●	●
Multi-Potential Steps (STEP)				●	●
Open Circuit Potential - Time (OCPT)	●	●	●	●	●
Full version of CV simulation and fitting program				●	●
Limited version of CV simulation and fitting program	●	●	●		

&: Corresponding stripping mode can be performed.

Specifications

8-Channel potentiostat

(8 independent cells or a multi-working electrode cell)

Potential range (all channels): ± 10 V

Applied potential accuracy: ± 1 mV, $\pm 0.01\%$ of scale

Potentiostat rise time: < 2 μ s

Applied potential noise: < 10 μ V rms

Compliance voltage: ± 12 V

Current range (each channel): 10 mA

Reference electrode input impedance: 1×10^{12} ohm

Sensitivity scale: 1×10^{-9} - 0.001 A/V in 7 ranges

Measured current resolution: 0.0015% of current range, minimum 0.3 pA

Input bias current: < 50 pA

Fast waveform updating rate: 5 MHz @ 16-bit

Fast data acquisition: up to 1 MHz @ 16-bit

- CV and LSV scan rate:
 - 0.000001 to 5000 V/s (sequential scan)
 - 0.000001 to 25 V/s (8 channel simultaneous scan)
 - Potential increment during scan: 0.1 mV @ 500 V/s
- CC and CA pulse width: 0.0001 to 1000 sec
- CA and CC sample interval:
 - 1e-6 to 50 s (sequential step)
 - 8e-5 to 50 s (8 channel simultaneous step)

- DPV and NPV pulse width: 0.001 to 10 sec
 - SWV frequency:
 - 1 to 100 KHz (sequential scan)
 - 1 to 3125 Hz (8 channel simultaneous scan)
 - ACV frequency:
 - 1 to 10000 Hz (sequential scan)
 - 1 to 312 Hz (8 channel simultaneous scan)
 - SHACV frequency:
 - 1 to 5000 Hz (sequential scan)
 - 1 to 250 Hz (8 channel simultaneous scan)
 - FTACV frequency: simultaneously acquire 1st, 2nd, 3rd, 4th, 5th, and 6th harmonics ACV data
 - 0.1 to 50 Hz (sequential scan)
 - 0.1 to 34 Hz (8 channel simultaneous scan)
 - i-t sample interval:
 - 1e-6 s to 100 s (sequential step)
 - 8e-5 s to 100 s (8 channel simultaneous step)
- Current low-pass filters
 Current analog output
 Cell control: purge, stir, knock
 Maximum data length: 128K-16384K selectable
 Dimensions: 14.25"(W) \times 9.25"(D) \times 4.75"(H)

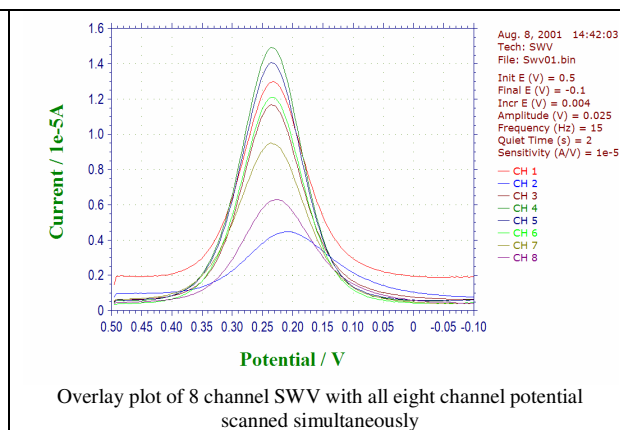
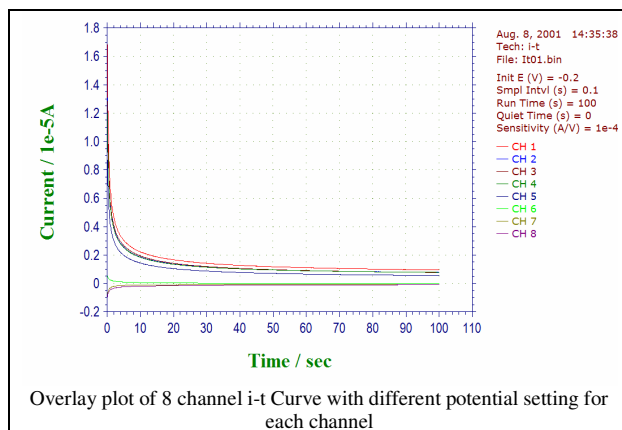

Model 1100D Series Power Potentiostat / Galvanostat

The Model 1100D series power potentiostat/galvanostat is designed for electrochemical applications that require relatively large current and high compliance voltage, such as battery studies, corrosion, electrolysis, and electroplating. The potential control range is ± 10 V, the current range is ± 2 A, and the compliance voltage is ± 25 V. The system contains a high speed digital function generator, a fast data acquisition system, current signal filters, iR compensation circuitry, a potentiostat, and a galvanostat (1140D only). The function generator can update at a 10 MHz rate, and the maximum sampling rate is 1 MHz at 16-bit resolution. The 1100D series is capable of measuring current down to tens of picoamperes. The steady state current of a 10 μm disk electrode can be readily measured without external adapters. The instrument provides a very wide dynamic range of experimental time scales. For instance, the scan rate in cyclic voltammetry can be up to 1000 V/s with a 0.1 mV potential increment, or 5000 V/s with a 1 mV potential increment. The potentiostat/galvanostat uses a 4-electrode configuration, allowing it to be used for liquid/liquid interface measurements and eliminating the effect of the contact resistance of connectors and relays for high current measurements. The data acquisition systems allow an external input signal (such as spectroscopic) to be recorded simultaneously with electrochemical data.

The model 1100D series is the upgrade from our model 1100C series. The major improvements are 3-4 times faster data transfer, and better protection of the power amplifier to avoid overheat and short circuit.

The 1100D series uses a USB port for data communication with the PC.

16-bit highly stable bias circuitry has been added for current or potential bias. This allows wider dynamic range in AC measurements. It can also be used to re-zero the DC current output.

We provide several different models in the 1100D series. The following table compares the different models. Other than what is listed, the specifications and features of these models are identical. Models 1100D/1110D are basic models, while Model 1140D is a more advanced model with a galvanostat.

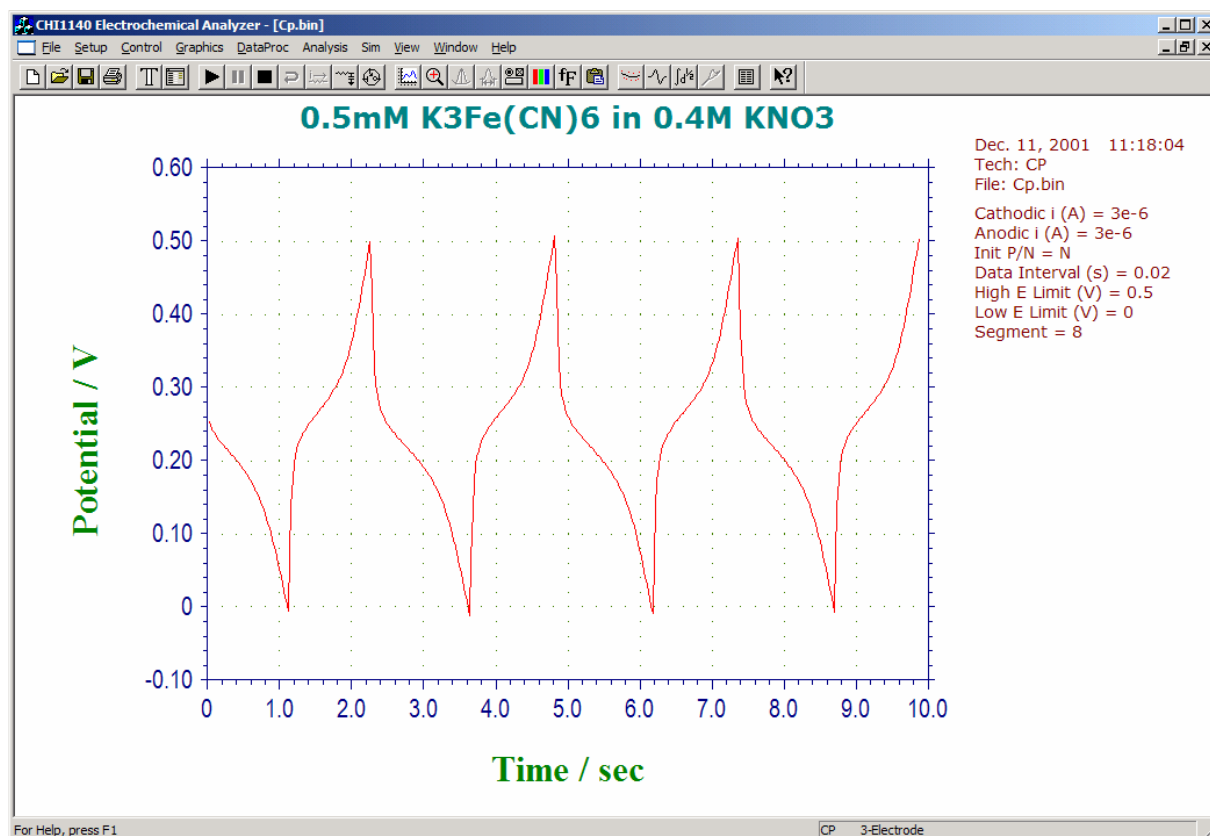

Chronopotentiometric measurement

Specifications

<p>Potentiostat Galvanostat (1140D only) Potential range: -10 to 10 V Applied potential resolution: 0.0015% of potential range Applied potential accuracy: ± 2 mV, $\pm 0.02\%$ of scale Potentiostat rise time: < 2 μs Compliance voltage: ± 25 V 3- or 4-electrode configuration Current range: ± 2 A Reference electrode input impedance: 1×10^{12} ohm Sensitivity scale: 1×10^{-12} - 0.1 A/V in 12 ranges Input bias current: < 50 pA Current measurement resolution: < 1 pA Potential update rate: 10 MHz Data acquisition: 16-bit @ 1 MHz External voltage signal recording channel External potential input Automatic and manual iR compensation Potential and current analog output RDE control voltage output: 0-10V (1130D and up)</p>	<p>CV and LSV scan rate: 0.000001 to 5000 V/s Potential increment during scan: 0.1 mV @ 1000 V/s CA and CC pulse width: 0.0001 to 1000 s CA and CC Steps: 320 DPV and NPV pulse width: 0.001 to 10 s SWV frequency: 1 to 100 kHz CA and i-t sample interval: minimum 1 μs ACV frequency: 0.1 to 10 kHz SHACV frequency: 0.1 to 5 kHz Automatic potential and current zeroing Signal low-pass filters, covering 8-decade frequency range, Automatic and manual setting Potential and current analog output Cell control: purge, stir, knock Automatic potential and current zeroing Current low-pass filters, covering 8-decade frequency range, Automatic and manual setting Flash memory for quick software update USB port for data communication Maximum data length: 128K-16384K selectable Dimension: 14.25"(W) \times 9.25"(D) \times 4.75"(H) Weight: 17 lb.</p>
---	--

Differences of 1100D Series Models

<i>Functions</i>	<i>1100D</i>	<i>1110D</i>	<i>1120D</i>	<i>1130D</i>	<i>1140D</i>
Cyclic Voltammetry (CV)	●	●	●	●	●
Linear Sweep Voltammetry (LSV) &	●	●	●	●	●
Staircase Voltammetry (SCV) #,&				●	●
Tafel Plot (TAFEL)				●	●
Chronoamperometry (CA)	●		●	●	●
Chronocoulometry (CC)	●		●	●	●
Differential Pulse Voltammetry (DPV) #,&		●	●	●	●
Normal Pulse Voltammetry (NPV) #,&		●	●	●	●
Differential Normal Pulse Voltammetry (DNPV) #,&					●
Square Wave Voltammetry (SWV) &			●	●	●
AC Voltammetry (ACV) #,&,\$				●	●
2nd Harmonic AC Voltammetry (SHACV) #,&,\$				●	●
Amperometric i-t Curve (i-t)				●	●
Differential Pulse Amperometry (DPA)					●
Double Differential Pulse Amperometry (DDPA)					●
Triple Pulse Amperometry (TPA)					●
Bulk Electrolysis with Coulometry (BE)	●		●	●	●
Sweep-Step Functions (SSF)					●
Multi-Potential Steps (STEP)					●
Chronopotentiometry (CP)					●
Chronopotentiometry with Current Ramp (CPCR)					●
Multi-Current Steps (ISTEP)					●
Potentiometric Stripping Analysis (PSA)					●
Open Circuit Potential - Time (OCPT)	●	●	●	●	●
Galvanostat					●
RDE control (0-10V output)					●
Full version of CV simulation and fitting program				●	●
Limited version of CV simulation and fitting program	●	●	●		
iR Compensation	●	●	●	●	●
External Potential Input	●	●	●	●	●
Auxiliary Signal Measurement Channel	●	●	●	●	●

#: Corresponding polarographic mode can be performed.

&: Corresponding stripping mode can be performed.

Model 1200C Series Hand-held Potentiostat / Bipotentiostat

The Model 1200C series is a computerized hand-held potentiostat/bipotentiostat. The system contains a digital function generator, a data acquisition system, and a potentiostat/bipotentiostat, and it is well suited for electroanalysis and sensor studies. The potential range is ± 5 V and the current range is ± 50 mA. This series is capable of measuring current down to 100 pA. The steady state current of a 10 μ m disk electrode can be readily measured. The size of the instrument is 7" (L) \times 4.5" (W) \times 1" (H). The instrument is powered by the USB port of an external computer, without need of an AC adapter or batteries. Due to its small size, light weight, and low cost, it is particularly useful for field applications and teaching laboratories.

The model 1200C series allows ± 11 V compliance voltage, which ensures its working potential range of ± 5 V for most electrochemical systems. It also uses dual 16-bit DAC and 16-bit ADC for high resolution and accuracy.

The instrument provides many powerful functions, such as straightforward file handling, extensive experimental control, flexible graphics, various data analysis, and efficient digital simulation. Some of the unique features include macro commands, working electrode conditioning, color, legend and font selection, data interpolation, visual baseline correction, data point removal, visual data point modification, signal averaging, Fourier spectrum, and a convenient technique-specific electrochemical equation viewer.

The 1200C series provides various instrument models to meet different applications and budgets, and is available in potentiostat (1200C, 1210C, 1220C, 1232C, and 1240C) and bipotentiostat versions (1202C, 1212C, 1222C, 1232C and 1242C).

Specifications

Potentiostat / bipotentiostat	CV and LSV scan rate: 0.000001 to 80 V/s
Maximum potential range: ± 5 V	CA and CC pulse width: 0.001 to 1000 s
Compliance voltage: ± 11 V	CA and CC Steps: 1 - 320
Current range: ± 50 mA	DPV and NPV pulse width: 0.001 to 10 s
Reference electrode input impedance: 1×10^{12} ohm	SWV frequency: 1 to 5000 Hz
Sensitivity scale: 1×10^{-9} - 0.01 A/V in 8 ranges	Low-pass filter for current measurements
Input bias current: < 100 pA	Maximum data length: 128K-16384K selectable
Current measurement resolution: < 1 pA	Power: USB port
Data acquisition: 16-bit @ 100 kHz	Chassis dimension: 7" (W) \times 4.5" (D) \times 1" (H)

Differences of 1200C Series Models

Functions	1200C /1202C	1205C /1206C	1207C /1208C	1210C /1212C	1220C /1222C	1230C /1232C	1240C /1242C
Cyclic Voltammetry (CV)*	●	●	●	●	●	●	●
Linear Sweep Voltammetry (LSV) &*	●	●	●	●	●	●	●
Chronoamperometry (CA)*	●				●	●	●
Chronocoulometry (CC)	●				●	●	●
Differential Pulse Voltammetry (DPV) &*				●	●	●	●
Normal Pulse Voltammetry (NPV) &*				●	●	●	●
Differential Normal Pulse Voltammetry (DNPV) &*						●	●
Square Wave Voltammetry (SWV) &*					●	●	●
AC Voltammetry (ACV) &							●
2nd Harmonic AC Voltammetry (SHACV) &							●
Amperometric i-t Curve (i-t)*		●	●			●	●
Differential Pulse Amperometry (DPA)			●			●	●
Double Differential Pulse Amperometry (DDPA)			●			●	●
Triple Pulse Amperometry (TPA)			●			●	●
Sweep-Step Functions (SSF)							●
Multi-Potential Steps (STEP)							●
Open Circuit Potential - Time (OCPT)	●	●	●	●	●	●	●
Full version of CV simulation and fitting program						●	●
Limited version of CV simulation and fitting program	●	●	●	●	●		

&: Corresponding stripping mode can be performed.

*: Second channel (bipotentiostat mode) can be performed.

Model 1400 Series Four-Channel Potentiometer / Four-Channel Potentiostats

The model 1400 series is a computerized four-channel potentiometer and four-channel potentiostat. The system contains a digital function generator and multiplexed data acquisition circuitry. The instrument can work with eight independent cells or eight working electrodes in the same solution with common reference and counter electrodes.

The potentiometer has high input impedance and low input bias current. The input range is ± 10 V, allowing dc coupled or ac coupled. A gain of 10 is also allowed. The potentiostat has a potential control range of ± 10 V and the current range is ± 10 mA. The instrument is capable of measuring current down to picoamperes. Each electrode can be individually controlled, including on/off control, potential, and sensitivity settings; each can be set to an independent potential or the same potential as the primary channel, so that they can sweep or step potentials together with the primary channel. The instrument allows eight independent cells, simultaneous or sequential measurements, fast waveform generation and data acquisition speed (1M Hz @ 16-bit), and easy software update using flash memory.

The model 1400 series can be used for array electrode characterization and sensor studies which require simultaneous measurement at a combination of sensors requiring techniques such as amperometry or voltammetry with sensors employing open-circuit methods, such as ion selective electrodes.

The analyzer is essential for real-time sensing at sensor arrays employing combinations of sensors for real-time detection of analytes in flux in cellular metabolism, either in 2D or 3D culture. The combination of open circuit potential with other methods allows for the addition of ion sensors such as H^+ , K^+ , and Cl^- , with sensors critical to metabolism, such as glucose, lactate, and oxygen. Additional sensing can be achieved through the Macro function in the Analyzer program, allowing for switching between amperometric and voltammetric measurements at the same electrodes, or conductivity measurements to determine salinity at additional electrodes in the array. This flexibility allows for a wide range of sensors measurements schemes.

Many electrochemical techniques are available in the 1400 series. The parameters for all channels must be set before running an experiment; you cannot alter parameter settings during experiments. During a run, you can toggle between single and multi-data set display (parallel or overlay plots). After a run, you can choose data from any channel for parallel or overlay plotting.

The instrument can be controlled by an external PC running Windows 7/10. It is easy to install and use. The instrument connects to your PC using a USB port connectivity; no plug-in card or other hardware is required on the PC side. The commands, parameters, and options have been written using terminology that most chemists are familiar with. A customizable toolbar allows quick access to the most commonly used commands. A comprehensive help system provides context-sensitive information from each dialog box.

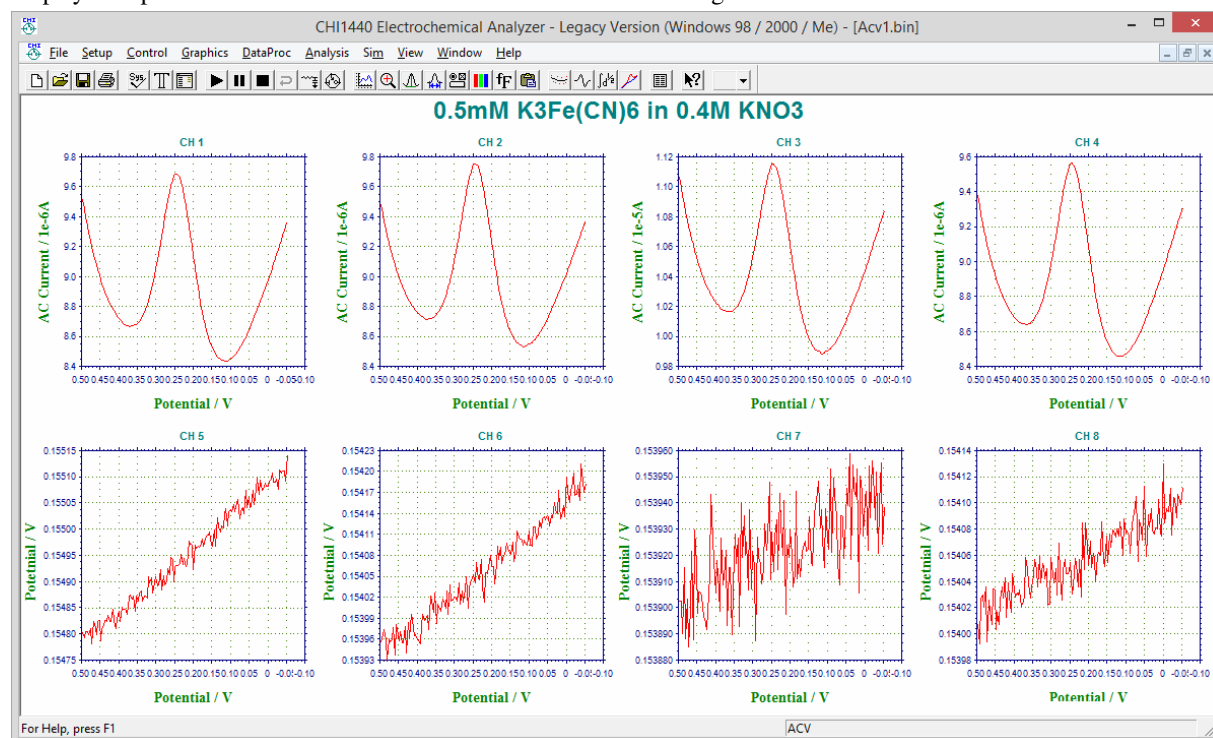

The instrument provides many powerful functions, such as straightforward file handling, extensive experimental control, flexible graphics, various data analyses, and efficient digital simulation. Additional features include macro commands, working electrode conditioning, color, legend and font selection, data interpolation, visual baseline correction, data point removal, visual data point modification, signal averaging, Fourier spectrum, and a convenient technique-specific electrochemical equation viewer. The maximum data length is 128K – 16384K points (selectable) if real-time data transfer is allowed.

Differences of 1400 Series Models (Potentiostatic Function Only)

<i>Functions</i>	<i>1400</i>	<i>1410</i>	<i>1420</i>	<i>1430</i>	<i>1440</i>
Cyclic Voltammetry (CV)	●	●	●	●	●
Linear Sweep Voltammetry (LSV) &	●	●	●	●	●
Chronoamperometry (CA)				●	●
Chronocoulometry (CC)				●	●
Differential Pulse Voltammetry (DPV) &			●	●	●
Normal Pulse Voltammetry (NPV) &			●	●	●
Square Wave Voltammetry (SWV) &			●	●	●
AC Voltammetry (ACV) &					●
2nd Harmonic AC Voltammetry (SHACV) &					●
Fourier Transform AC Voltammetry (FTACV)					●
Amperometric i-t Curve (i-t)	●	●		●	●
Differential Pulse Amperometry (DPA)		●		●	●
Triple Pulse Amperometry (TPA)		●		●	●
Sweep-Step Functions (SSF)				●	●
Multi-Potential Steps (STEP)				●	●
Open Circuit Potential - Time (OCPT), total 5 channels	●	●	●	●	●
Full version of CV simulation and fitting program				●	●
Limited version of CV simulation and fitting program	●	●	●		

&: Corresponding stripping mode can be performed.

Specifications

Four-channel Potentiometer:

Input potential range: ± 10 V
 Input impedance: 1×10^{13} ohm
 Input bias current: ≤ 1 pA
 Dc and ac coupling
 Gain selection: 1 or 10

Four-channel Potentiostat:

Potential range (all channels): ± 10 V
 Applied potential accuracy: ± 1 mV, $\pm 0.01\%$ of scale
 Potentiostat rise time: < 2 μ s
 Applied potential noise: < 10 μ V rms
 Compliance voltage: ± 12 V
 Current range (each channel): 10 mA
 Reference electrode input impedance: 1×10^{12} ohm
 Sensitivity scale: 1×10^{-9} - 0.001 A/V in 7 ranges
 Measured current resolution: 0.0015% of current range, minimum 0.3 pA
 Input bias current: < 50 pA

Fast waveform updating rate: 5 MHz @ 16-bit
 Current low-pass filters

- CV and LSV scan rate:
 0.000001 to 5000 V/s (sequential scan)
 0.000001 to 25 V/s (8 channel simultaneous scan)
 Potential increment during scan: 0.1 mV @ 1,000 V/s
- CC and CA pulse width: 0.0001 to 1000 sec
- CA and CC sample interval:
 1e-6 to 50 s (sequential step)
 8e-5 to 50 s (8 channel simultaneous step)

- DPV and NPV pulse width: 0.001 to 10 sec
- SWV frequency:
 1 to 100 KHz (sequential scan)
 1 to 3125 Hz (8 channel simultaneous scan)
- ACV frequency:
 1 to 10000 Hz (sequential scan)
 1 to 312 Hz (8 channel simultaneous scan)
- SHACV frequency:
 1 to 5000 Hz (sequential scan)
 1 to 250 Hz (8 channel simultaneous scan)
- FTACV frequency: simultaneously acquire 1st, 2nd, 3rd, 4th, 5th, and 6th harmonics ACV data
 0.1 to 50 Hz (sequential scan)
 0.1 to 34 Hz (8 channel simultaneous scan)
- i-t sample interval:
 1e-6 s to 100 s (sequential step)
 8e-5 s to 100 s (8 channel simultaneous step)

Other features:

- Fast data acquisition: up to 1 MHz @ 16-bit for single channel, 12.5K Hz for 8 channel simultaneous
- Independent cells or a multi-working electrode cell
- Simultaneous eight channel measurements or sequential single channel measurements for higher speed and better signal averaging
- Current and potential analog output
- Cell control: purge, stir, knock
- Maximum data length: 128K-4096K selectable
- Dimensions: 14.25"(W) \times 9.25"(D) \times 4.75"(H)

CHI1550A Solution Dispenser

The CHI1550A solution dispenser is designed for making high density and high accuracy solution arrays, which can be used in chemical, biological and medical applications. The solution dispenser consists of a high-resolution three-dimensional positioner, a piezoelectric jetting device, and a sample platform, as shown in Figure 1.

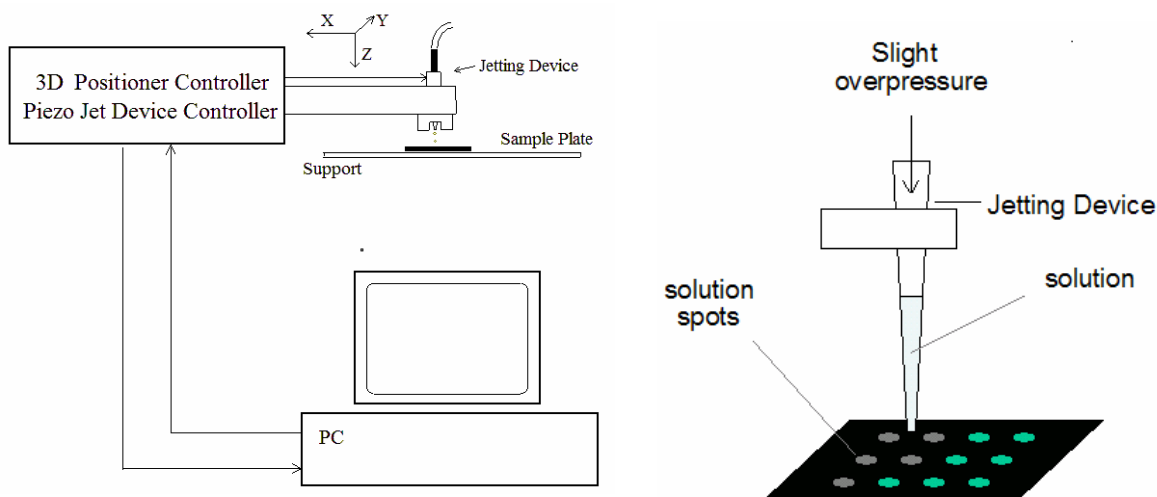

Figure 1. Diagram of the solution dispenser

The three-dimensional positioner can travel 50 mm in all three directions with 0.1 micrometer resolution, allowing high-precision patterning. This is particularly important when multiple overlapping solution components need to be dispensed.

The jetting device can dispense single drops of solutions with viscosity less than 40 centipoise and surface tension in the range of 0.02-0.07 N/m. Solutions with properties outside these limits can be jetted if changes to the properties can be achieved with solvents or changes in temperature. With a default nozzle size of 60 microns, the jetting device can produce drops ranging from 100-200 picoliters in volume, depending on the operating parameters and solution composition.

The CHI1550A solution dispenser control software is very user-friendly for creating binary, ternary and quaternary arrays of spots containing mixtures of solutions. Instead of using a manually created look-up table for solution dispensing patterns, pattern creation is facilitated by our software, which can also provide commonly used patterns as a default for binary, ternary, and quaternary arrays. The positioner can memorize certain critical positions, such as the solution loading point and first dispensing point, allowing the jetting device to go to these positions easily and quickly.

The array pattern can be examined graphically, and it will also be displayed during the dispensing process.

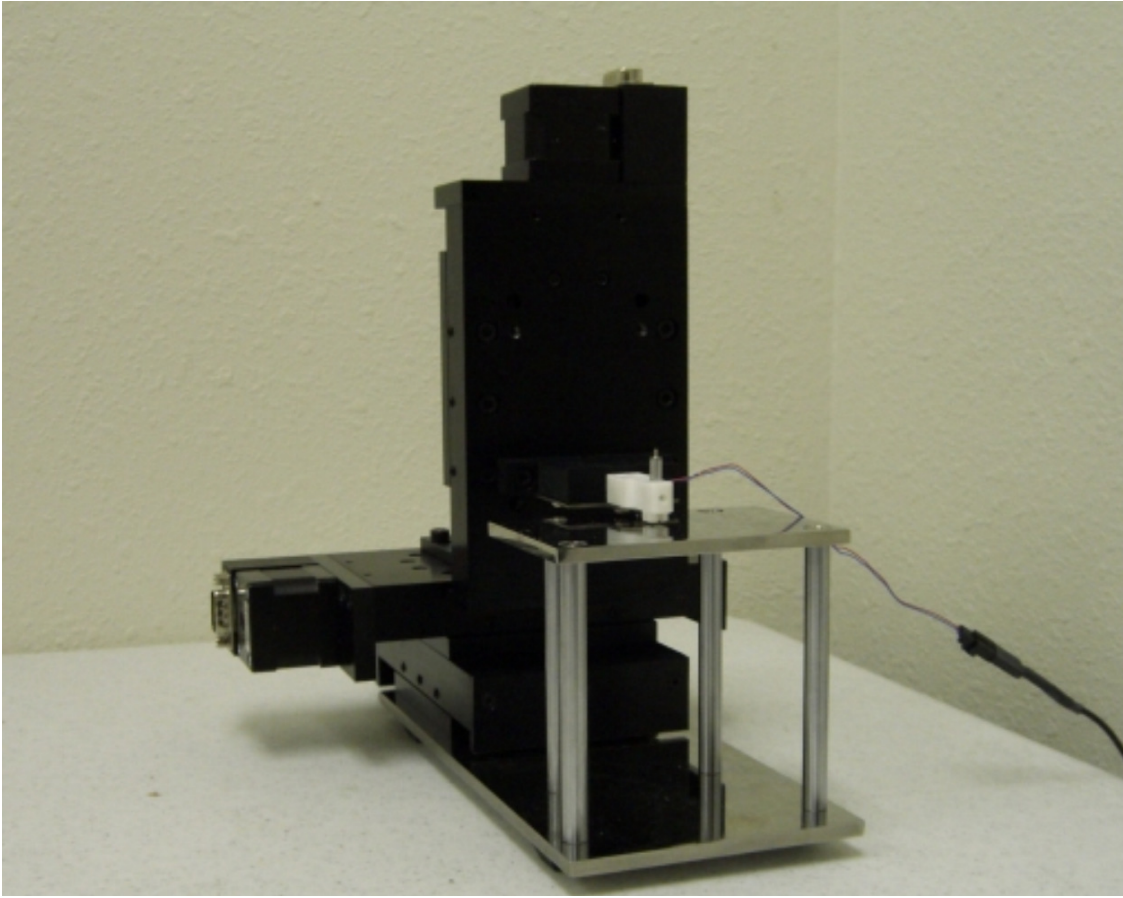

Figure 3. Micropositioner and sample stand

System requirements

Operating System: PC with Microsoft Windows 7/10.

Communication: USB port

Hardware Specifications

Micropositioner:	Jetting Device:
<ul style="list-style-type: none">• Maximum range of travel: 50 mm• Resolution: 0.1 μm• Stall Load: 50 N• Maximum Speed: 4 mm / sec	<ul style="list-style-type: none">• Orifice size of the jetting device: 60 micron• Droplet size: 100-200 picoliters• Control voltage: 0-150 V• A protective holder for the jetting device

CHI200B Picoamp Booster and Faraday Cage

With the CHI200(B) Picoamp Booster and Faraday Cage, current down to a few picoamperes can be readily measured. The CHI200 is compatible with the Model 600/A, 700/A series of instruments, while the CHI200B is compatible with Model 600B/C/D/E/F, 700B/C/D/E/F and 800B/C/D series. When used with 700/A/B/C/D/E/F and 800B/C/D series bipotentiostat, the Picoamp Booster will affect only the primary channel.

The internal sensitivity of the 600B/C/D/E/F series is the same as the Picoamp Booster (1×10^{-12} A/V). However, the bias current of the 600B/C/D/E/F series input can be as high as 50 pA. The Picoamp Booster has a lower bias current, and it also brings the preamplifier close to the electrode, resulting in lower noise. The Faraday Cage also makes it possible to make relatively fast measurements of small currents.

When the Picoamp Booster is connected and the sensitivity scale is at or below 1×10^{-8} A/V, the Picoamp Booster will be automatically enabled. Otherwise, it will be disabled. Detection and enabling/disabling of the Picoamp Booster are fully automatic and do not require user intervention.

The Picoamp Booster will be disabled for techniques using automatic sensitivity switching, such as Tafel plots and bulk electrolysis (BE). For galvanostatic techniques, such as chronopotentiometry (CP), chronopotentiometry with Current Ramp (CPCR), Mult-Current Steps (ISTEP), and potentiometric stripping analysis (PSA), the Picoamp Booster will not work. However, it works with AC impedance (IMP).

In addition to allowing weak signal measurements, the Faraday cage is useful for eliminating electrical interference, especially line frequency noise. If the electrochemical cell is picking up electrical noise from the environment, the additional use of Faraday cage is strongly recommended.

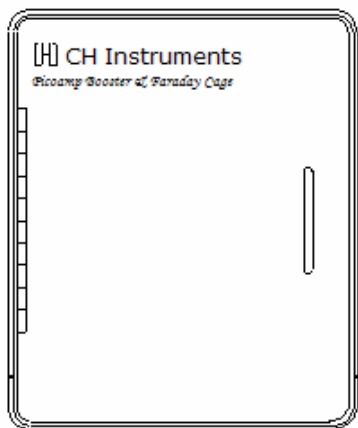

Front View

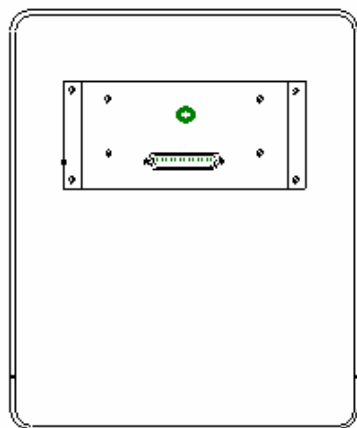

Rear View

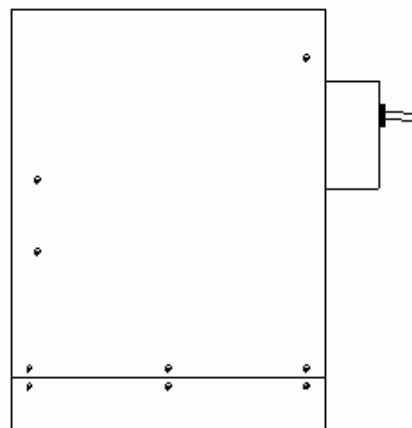

Side View

Dimension: 9.6"(W) × 8.8"(D) × 11.8"(H)

Weight: 10 lb.

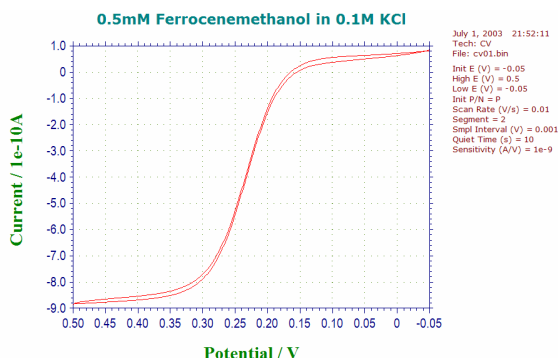

Cyclic voltammogram at an ultramicroelectrode.

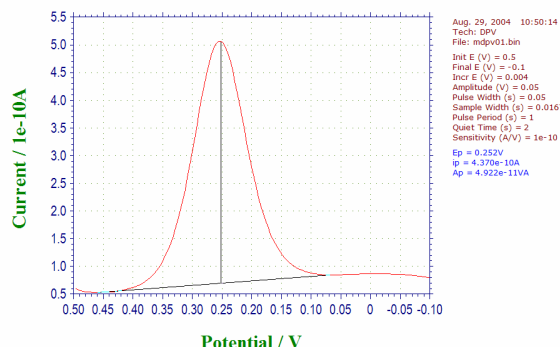

Differential pulse voltammogram at an ultramicroelectrode.

Model 680D Amp Booster

With the CHI680D Amp Booster, the current can be measured up to 2 A. The compliance voltage will be up to ± 25 V. The CHI680D is compatible with our model 600D/E/F series of instruments. You can stack the CHI600D/E/F and the CHI680D together. The CHI680D can also be connected to the model 700E/F series, but it will only work for the primary channel.

When the Amp Booster is connected, cell control signals such as purge, knock, and stir will be disabled.

The Amp Booster will also allow low current measurements. You may need to use a Faraday Cage to eliminate line frequency noise when the scan rate is above 50 mV/s.

The frequency response of the Amp Booster is somewhat lower than that of the CHI600F. For high speed experiments, the Amp Booster should be disconnected.

Dimension: 14.25"(W) \times 9.25"(D) \times 4.75"(H)

Weight: 17 lb.

CHI684 Multiplexer

CHI684 is a multi-channel multiplexer for the model 400/A/B/C, 600A/B/C/D/E/F, 700A/B/C/D/E/F, 800B/C/D, 900B/C/D and 1100A/B/C/D series. The multiplexer switches four lines (working, sensing, reference, and counter for single-channel potentiostats, second working, reference and counter for bipotentiostats). You can have up to 64 cells, but only one cell can be connected at a time.

The multiplexer is controlled using the "Multiplexer" command under the Control menu. You can select any channel(s) and run experiments in a sequence of selected channels. Data will automatically be saved to file after each run. You can also be prompted before each channel run.

It is allowed to set arbitrary channels immediately. An experiment can then be run for that particular channel.

Two Macro commands are available for the multiplexer. One is "mch:##", which allows the user to choose an individual channel. The other macro command is "mchn". This is used in a For...Next loop to select the channel according to the For...Next loop counter.

The minimum number of channels for the CHI684 is 8. The channel increment is 8. The maximum number of channels is 64.

Highlights

User Interface

- **Unicode tabbed-document application:** compatible with 32-bit and 64-bit Windows
- **monolithic, streamlined architecture:** minimal registry-free footprint
- **multiple instances:** control multiple instruments by simply duplicating the program
- **customizable toolbar:** quick access to favorite commands
- **status bar:** technique, file status, and command prompt
- **WYSIWYG graphics**
- **comprehensive context-sensitive help**

File Management

- **Unicode support:** international file and folder names
- **open data files:** read directly from binary or plain-text files
- **save data file:** binary, plain-text formats for exporting data (e.g., to spreadsheet)
- **list data file**
- **convert to text files:** for exporting multiple data files
- **text file format**
- **print present data**
- **print multiple data files**
- **print setup**

Experimental Setup

- **technique:** a large repertoire of electrochemical techniques
- **experimental parameters:** extremely wide dynamic range
- **system setup:** line frequency, potential/ current axis polarities
- **hardware test:** digital and analog circuitry diagnostic test

Instrument Control

- **run experiment:** real time data display in most cases
- **pause/resume during run**
- **stop running experiment**
- **reverse scan direction during run:** for cyclic voltammetry
- **repetitive runs:** automatic data save, signal averaging, delay or prompt between runs, up to 999 runs
- **run status:** stir, purge, iR compensation, smooth after run, RDE and SMDE control status
- **macro commands:** edit, save, read, and execute a series of commands
- **open circuit potential measurement**
- **iR compensation:** automatic and manual compensation, solution resistance, double layer capacitance and stability test
- **analog filter setting:** automatic or manual setting of potential, i/V converter, and signal filters
- **cell control:** purge, stir, cell on, SMDE drop collection, and pre-run drop knock
- **step functions:** initial and two step potentials, duration of steps and number of steps, particularly useful for electrode treatment
- **working electrode conditioning before running experiment:** programmable 3 steps

- **rotating disk electrode:** rotation speed, on/off control during deposition, quiescent time, run, and between runs
- **stripping mode:** enable/disable, deposition potential and time, stir and purge conditions

Graphical Display

- **present data plot**
- **3D surface plot:** front, rear, side, top and bottom view
- **overlay plots:** several sets of data overlaid for comparison
- **add data to overlay:** adding data files to overlay plot
- **parallel plots:** several sets of data plotted side by side
- **add data to parallel:** adding data files to parallel plot
- **zoom in/out:** visually selected zoom area
- **manual results:** visually selected baseline
- **peak definition:** shape, width, and report options
- **Special Plots:** x-y, i_p -v, i_p -v^{1/2}, E_p -log v, semilog plots, linear polarization resistance plot
- **graph options:** video or printer options, axis, parameters, baseline, results, grids, axis inversion, axis freeze, axis titles, data sets, XY scales, current density option, reference electrode, header, and notes
- **3d plotting (NEW):** interactive visualization of impedance data and SECM results; Laplacian smoothing, Delaunay triangulation, and stereoscopic 3D anaglyph imaging (no special video card or display required)

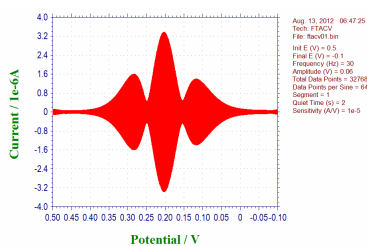

Fourier Transform ACV 3rd Harmonics

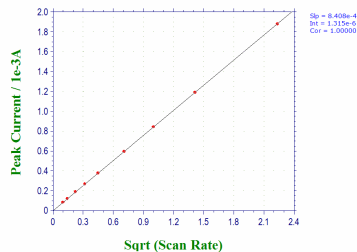

Automatic $i_p \sim v^{1/2}$ plot.

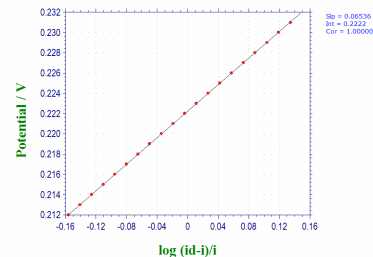

Automatic semilog plot.

Highlights

- **color and legend:** background, axis, grid, curves, legend size, thickness, and display intervals
- **font:** font, style, size and color for axis labels, axis titles, header, parameters, and results
- **copy to clipboard:** for pasting the data plot to word processors

Data Processing

- **smoothing:** 5-49 point least square and Fourier transform
- **derivatives:** 1st - 5th order, 5-49 point least square
- **integration**
- **convolution:** semi-derivative and semi-integral
- **interpolation:** 2× - 64× data interpolation
- **baseline correction:** visually selected baseline, slope and dc level compensation
- **baseline fitting and subtraction:** selectable fitting function, polynomial order and potential range for best fitting and baseline subtraction; particularly useful for trace analysis
- **data point removing**
- **data point modifying:** visual data point modification
- **background subtraction:** difference of two sets of data
- **signal averaging**
- **mathematical operations:** both X and Y data array
- **Fourier spectrum**

Analysis

- **calibration curve:** calculation and plot

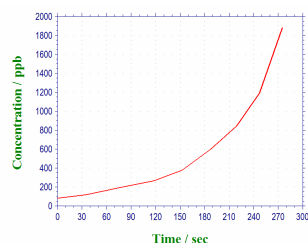

Concentration-time dependence plot.

- **standard addition:** calculation and plot
- **data file report:** analytical report from existing data files
- **time dependence report**
- **corrosion rate calculation**

Digital CV Simulation and Fitting

- **fast implicit finite difference algorithm**
- **reaction mechanisms:** 10 predefined mechanisms (low end models); or any combination involving electron transfer, first- and second-order chemical reactions (high end models)
- **system:** diffusive or adsorptive
- **maximum equations:** 12
- **maximum species:** 9
- **simulation parameters:** standard redox potentials, rate of electron transfer, transfer coefficient, concentration, diffusion coefficient, forward and reverse chemical reaction rate constants, temperature, electrode area, and experimental parameters
- **simultaneous display of voltammogram and concentration profiles**
- **automatic search and determine over-determined equilibrium constants**
- **dimensionless current**
- **equilibrium data**

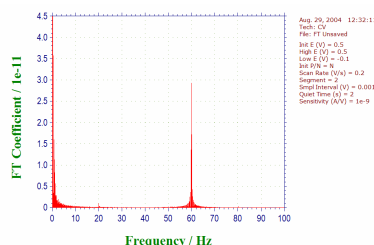

Fourier spectrum.

AC Impedance Simulation and Fitting

- **visual entry of equivalent circuitry**
- **automatic equivalent circuit parameters fitting**

View

- **data information:** date, time, filename, data source, instrument model, data processing performed, header and notes
- **data listing:** data information and numerical data array
- **equations:** general equations and equations relating to various electrochemical techniques
- **SECM probe status:** probe position and current display
- **clock**
- **toolbar**
- **status bar**

Help

- **context sensitive help**
- **help topics**
- **about the application**

System requirements

- **operating system:** Microsoft Windows 7 / 10
- **USB port for communication**

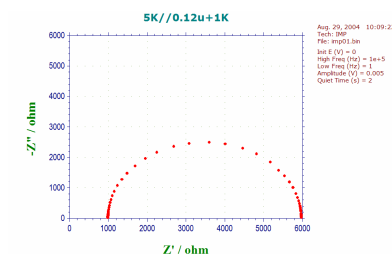

Nyquist plot of impedance data.

Highlights

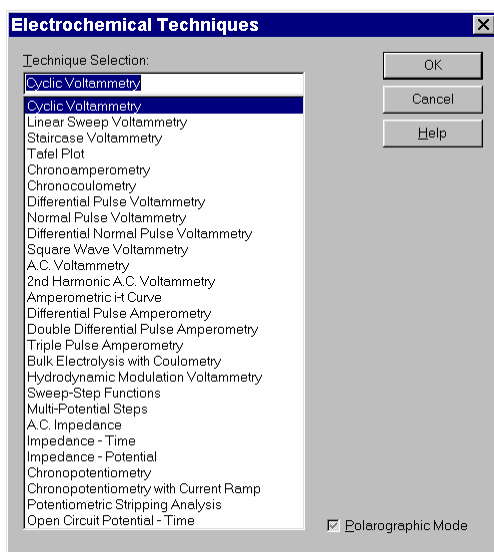

A large repertoire of electrochemical techniques.

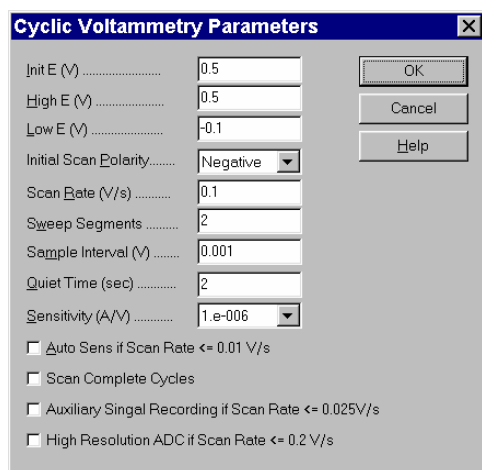

Experimental parameter dialog box for Cyclic Voltammetry.

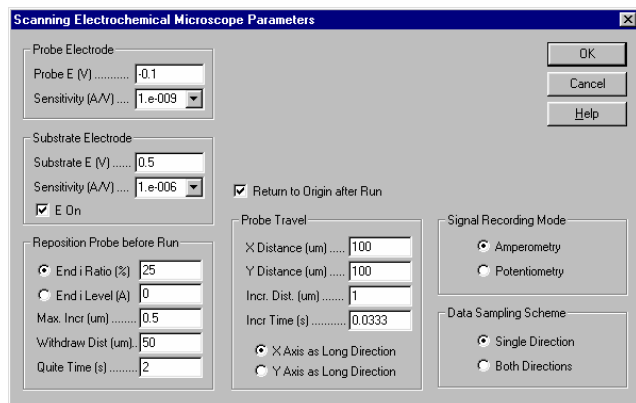

Experimental parameter dialog box for SECM.

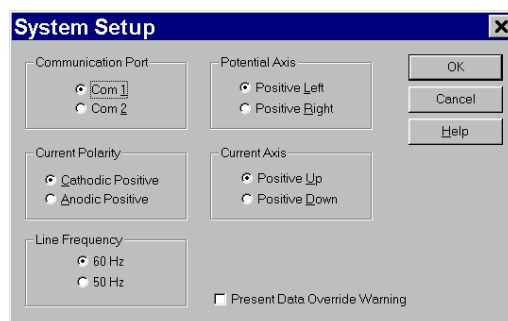

System setup allows any convention of current and potential polarity.

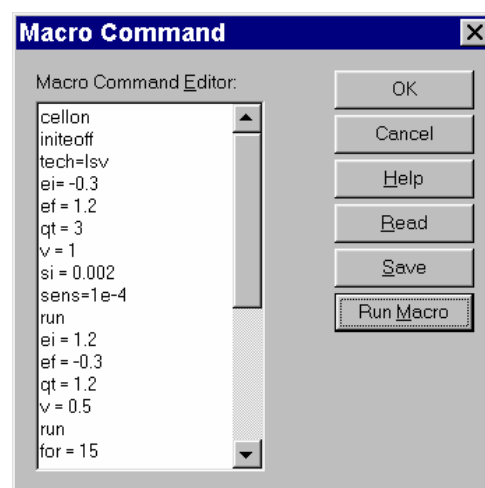

The Macro command allows a series command to be executed in a sequence..

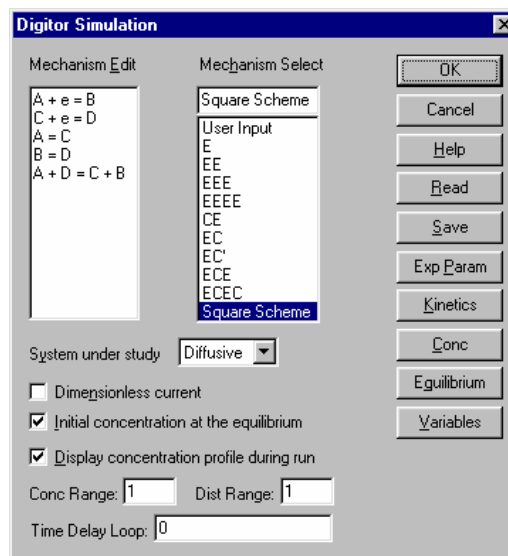

User interface for digital simulator.

Highlights

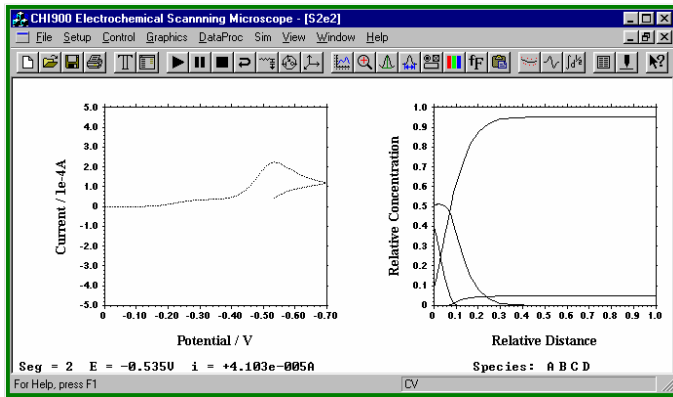

CV Simulation displays both current response and the concentration profiles of different species during the simulation process.

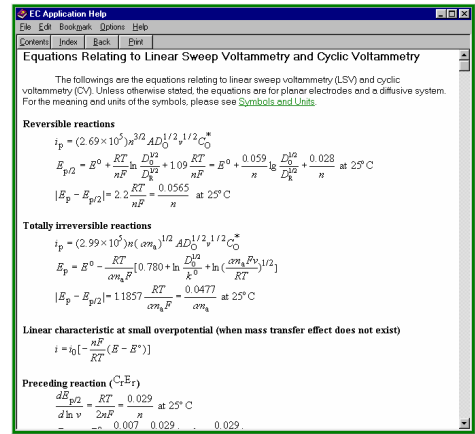

Equations relating to various techniques can be viewed from our software.

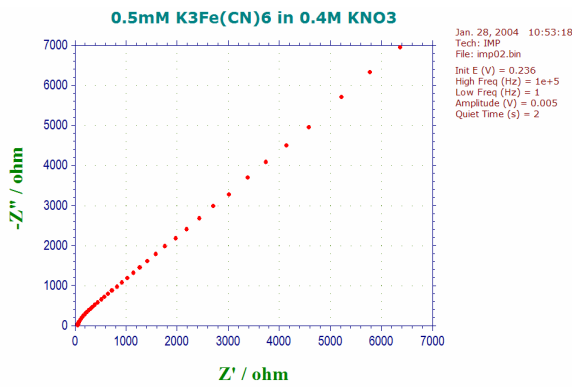

Impedance data plot.

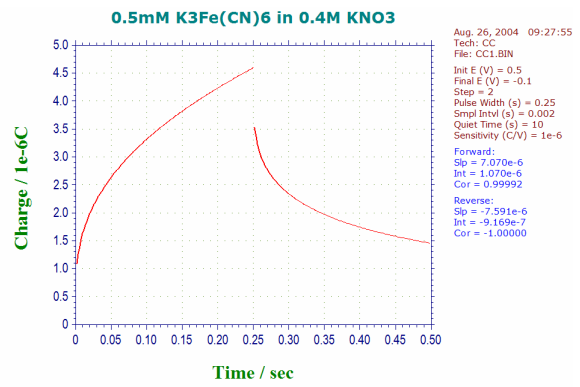

Chronocoulometric data.

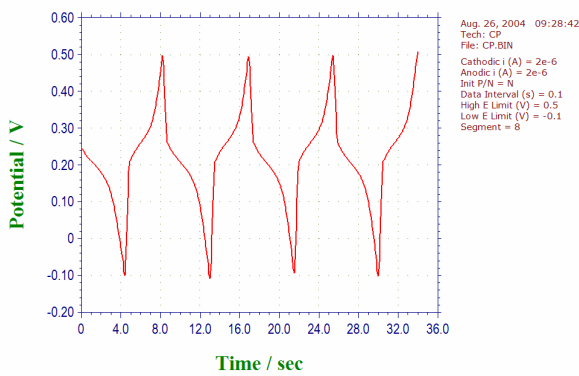

Multi-cycle chronopotentiometric data.

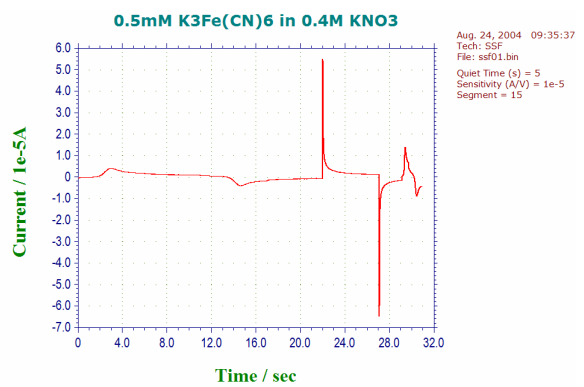

Multi-segment sweep-step functions data..

Accessories

Part No.	Description	Unit	Part No.	Description	Unit
CHI101	2 mm dia. Gold Working Electrode	1	CHI130	Thin-Layer Flow Cell	1
CHI101P	2 mm dia. Gold Working Electrode	3/pk	CHI131	GC Working Electrode for Flow Cell	1
CHI102	2 mm dia. Platinum Working Electrode	1	CHI132	Au Working Electrode for Flow Cell	1
CHI102P	2 mm dia. Platinum Working Electrode	3/pk	CHI133	Pt Working Electrode for Flow Cell	1
CHI103	2 mm dia. Silver Working Electrode	1	CHI134	Reference Electrode for Flow Cell	1
CHI104	3 mm dia. Glassy Carbon Working Electrode	1	CHI135	25 μ m Spacer for Flow Cell	4/pk
CHI104P	3 mm dia. Glassy Carbon Working Electrode	3/pk	CHI140A	Spectroelectrochemical Cell	1
CHI105	12.5 μ m dia. Gold Microelectrode	1	012167	Ag/AgCl Reference electrode for CHI140A	1
CHI105P	12.5 μ m dia. Gold Microelectrode	3/pk	012171	Ag/Ag+Non Aqueous Ref electrode for CHI140A	1
CHI106	25 μ m dia. Gold Microelectrode	1	CHI150	Calomel Reference Electrode	1
CHI106P	25 μ m dia. Gold Microelectrode	3/pk	CHI151	Mercury/Mercurous Sulfate Reference Electrode	1
CHI107	10 μ m dia. Platinum Microelectrode	1	CHI152	Alkaline/Mercurous Oxide Reference Electrode	1
CHI107P	10 μ m dia. Platinum Microelectrode	3/pk	CHI172-Model #	Electrode leads for a particular instrument model number	1
CHI108	25 μ m dia. Platinum Microelectrode	1	CHI200	Picoamp Booster and Faraday Cage ³	1
CHI108P	25 μ m dia. Platinum Microelectrode	3/pk	CHI201	Picoamp Booster	1
CHI111	Ag/AgCl Reference Electrode, (porous Teflon tip)	1	CHI202	Faraday Cage	1
CHI111P	Ag/AgCl Reference Electrode, (porous Teflon tip)	3/pk	CHI220	Simple Cell Stand ⁴	1
CHI112	Non-Aqueous Ag/Ag ⁺ Reference Electrode ¹	1	CHI221	Cell Top (including Pt wire counter electrode, not a replacement part for the CHI200 cell stand) ⁵	1
CHI112P	Non-Aqueous Ag/Ag ⁺ Reference Electrode ¹	3/pk	CHI222	Glass Cell	1
CHI115	Platinum Wire Counter Electrode	1	CHI223	Teflon Cap ⁵	1
CHI116	10 μ m dia. Platinum SECM Tip	1	012125	IDA Gold Electrode	1
CHI116P	10 μ m dia. Platinum SECM Tip	3/pk	012126	IDA Platinum Electrode	1
CHI117	25 μ m dia. Platinum SECM Tip	1	012127	IDA Carbon Electrode	1
CHI117P	25 μ m dia. Platinum SECM Tip	3/pk	012033	CS-3 Remote Controllable Cell Stand	1
CHI120	Electrode Polishing Kit ²	1	011121	QCM Flow Cell Kit (no ref electrode)	1
CHI125	Polished, Bounded, Mounded 100A Ti + 1000 A Gold Crystal for EQCM	1	012026	EQCM Flow Cell Kit (no ref electrode)	
CHI127	EQCM Cell	1	TE100	Printed Electrodes (3-electrodes)	40/pk
CHI128	Reference Electrode for EQCM Cell	1	SE101	3mm dia. Printed carbon electrode	40/pk
CHI129	Pt Wire Counter Electrode for EQCM Cell	1			

Notes:

1. Ag⁺ solution (typically 10 mM) should be prepared with the supporting electrolyte and AgNO₃ (not included). This solution is then filled into the reference electrode compartment using a syringe (not included). The instructions will come with the components.
2. The electrode polishing kit contains 1 bottle of 1.0 micron Alpha alumina powder, 1 bottle of 0.3 micron Alpha alumina powder, 3 bottles of 0.05 micron Gamma alumina powder, 2 glass plates for polishing pads, 5 pieces of 73 mm diameter 1200 grit Carbimet disks (grey in color), 5 pieces of 73 mm diameter Mastertex polishing pads (white in color), and 10 pieces of 73 mm diameter Microcloth polishing pads (brown in color).
3. The Picoamp Booster and Faraday Cage allow current measurements down to 1 pA. Usage is fully automatic and compatible with our model 600F and 700F series instruments (primary channel only)..
4. Made of stainless steel and Teflon (see figure below). *Not* remote-controllable. Four glass cells are included.
5. Not a replacement part for the CHI220 Cell Stand.

Accessories and Instrument Chassis



CHI101/102/103/104 Working Electrodes

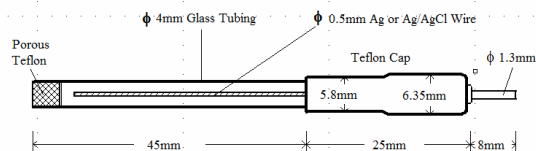

CHI111/112 Reference Electrodes

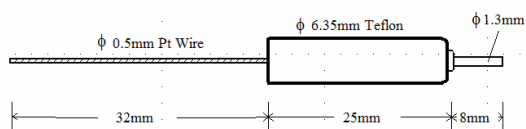

CHI115 Pt Wire Counter Electrode

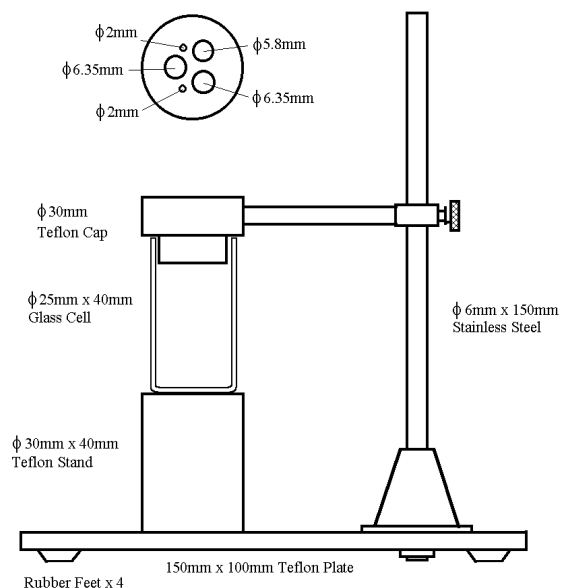

CHI220 Cell Stand



CHI130 Thin-Layer Flow Cell



Front and rear view of the Model 400C, 600F, 700F, 800D, and 1100C series instruments

Screen-Printed Electrode

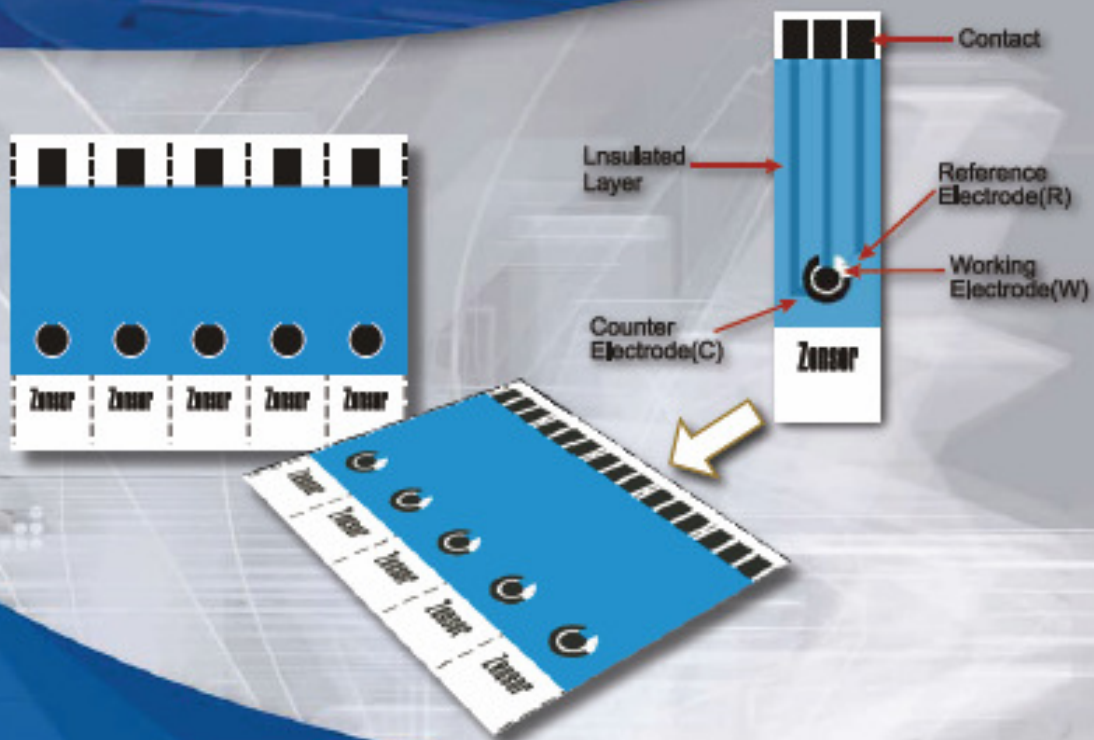

Glassy Carbon Electrode

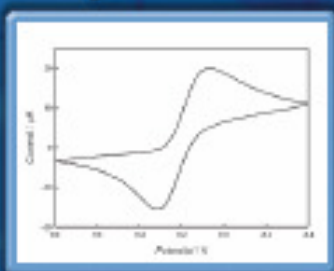

Screen-Printed Electrode

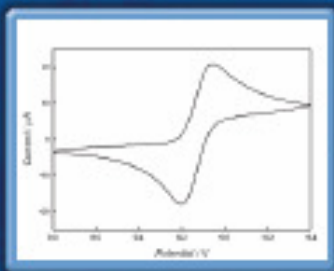

- Disposable/Reusable
- Extendable Applicability after Preanodization
- Needless of Polishing Electrode
- Easy for Chemical Modification
- Superior in Combinatorial Study
- Low Cost
- In-Built Three-Electrode Configuration

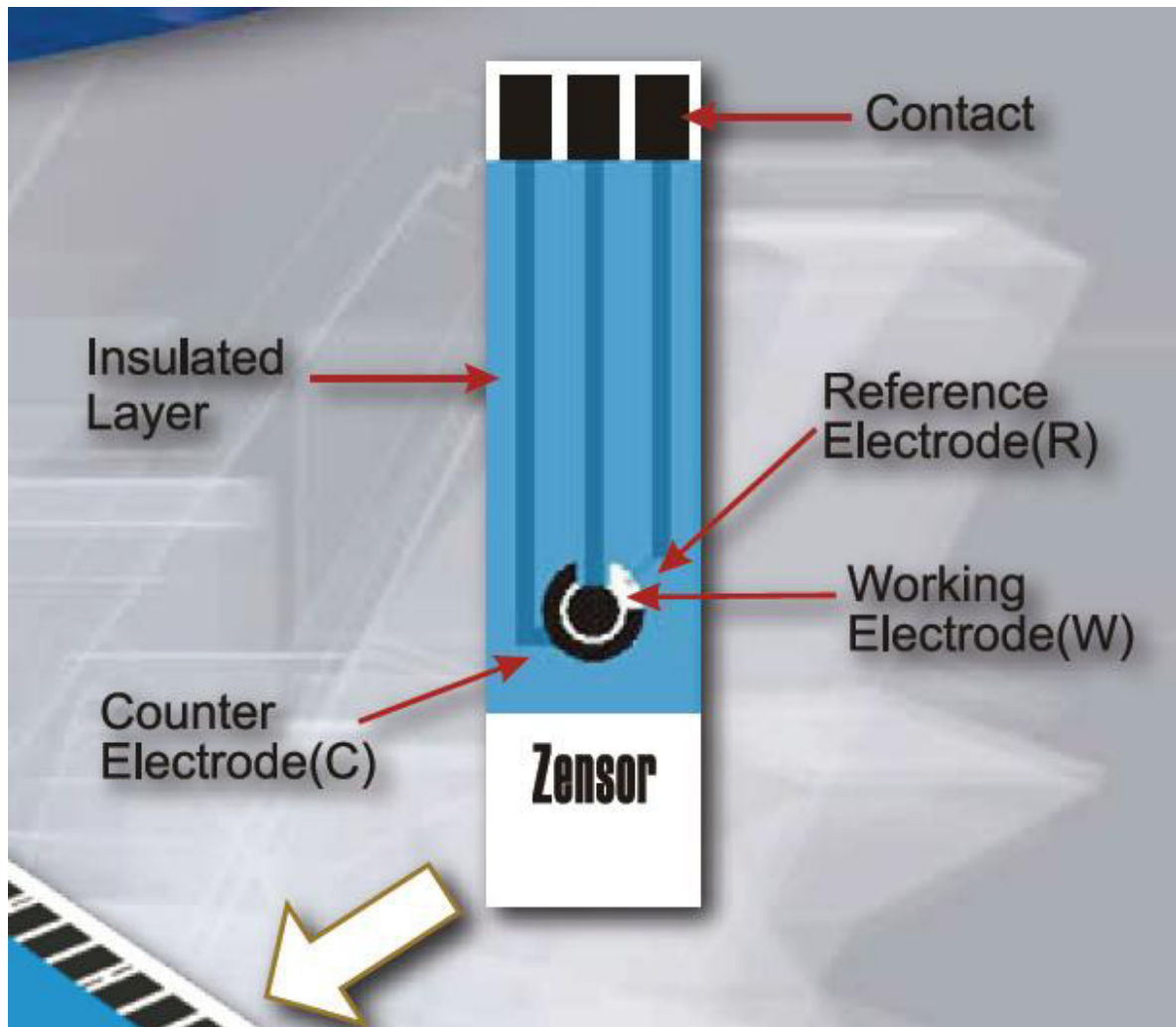

TE100 Screen Printed Electrode.

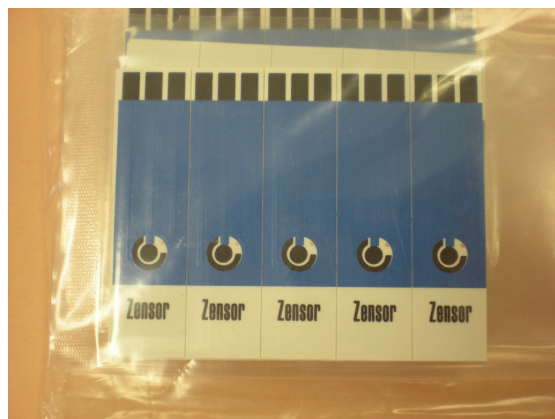

TE100: three electrodes with 3mm diameter working electrode.

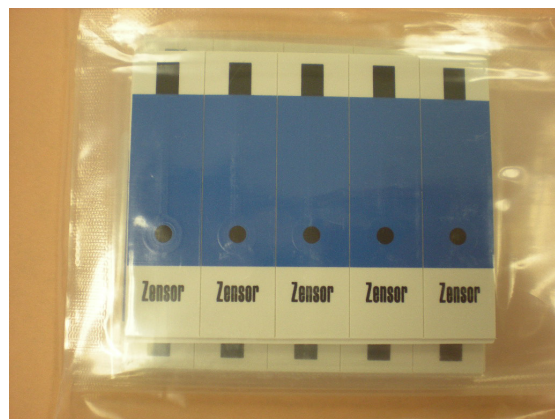

SE101: single disk working electrode (3mm diameter)



Bridge on Colorado River,
Austin, Texas



Our office building in
Austin, Texas.

Warranty:

One-year warranty on electronic parts and labor, 90-day warranty on mechanical parts.

Demo Software:

Free demo software available upon request.

 CH Instruments, Inc.

3700 Tennison Hill Drive • Austin, TX 78738 • USA

Tel: (512) 402-0176 • Fax: (512) 402-0186

E-mail: info@chinstruments.com

Web Page: <http://www.chinstruments.com>

© October 2020 CH Instruments, Inc.
All rights reserved.

Send to: